

SPINAL SURGERY INSTRUMENTATION



International Instruments
Designers & Manufacturers of Surgical Instruments



International Instruments

the instruments people

JJ International Instruments is engaged in Designing, Manufacturing and Distribution of 100% pure quality Stainless Steel surgical instruments for all department of surgery in the Sultanate of Oman

JJ International Instruments is a rare union of highly skilled surgical craftsmen, guaranteed raw material and modern technology that results in high quality surgical instruments

We take great pride in the extensive range of over 15,000 quality instruments that we offer in a multitude of disciplines.

Our dedicated R&D department has acclaimed many golden feathers in their hat by modifying, designing and manufacturing complex instruments according to surgeon's requirements.

Even more importantly, we have a very significant policy of effective 'service after sales' to the satisfaction of our entire clients.

LAMINECTOMY PUNCHES

90° Kerrison Laminectomy Punch	1
'Black Line' Kerrison Punch	2
Bone Ejector Kerrison Punch	2
Thin Footplate Kerrison Punch	3
Wide Opening Kerrison Punch	3
'Clean Wave' Laminectomy Punch	4
Love Kerrison Punch	4
Long Anterior Kerrison Punch	5
Curved Foramenotomy Punch	5
Ferris-Smith Kerrison Punch	6
Osteo-Rotating Punch	6

DISC RONGEURS

Intervertebral Disc Rongeur	7
Caspar Disc Rongeur	8
Schlesinger Toothed Rongeur	8
Williams Disc Rongeur	9
'Pea Pod' Disc Rongeur	9
Beck Disc Rongeur	9
Munich Grasping Forceps	10
Decker Rongeur	10
Nicola Biopsy Forceps	10
'Clean Wave' Intervertebral Rongeur	11
Ferris-Smith Rongeur	12
Anterior Disc Rongeur	12
Anterior Long Rongeur	12

BONE NIBBLERS & CUTTERS

Lempert Bone Nibbler	13
Luer Bone Nibbler	13
Adsons Bone Nibbler	13
Pennybacker Bone Nibbler	14
Northfields Bone Nibbler	14
'Rat Toothed' Bone Nibbler	14
Zielke Rongeur	15
Matzen Rongeur	15
Beyer Bone Nibbler	15
Jansen Bone Nibbler	16
Marquardt Bone Nibbler	16
Smith-Peterson Bone Nibbler	16
Stille-Luer Bone Nibbler	17
Leksell Bone Nibbler	17
Echlin Duckbill Nibbler	18
Long Anterior Leksell Bone Nibbler	18
Sypert Bone Nibbler	18
McIndoe Bone Cutters	19
Stille-Liston Bone Cutters	19
Liston-Key-Horsley Bone Cutters	19
Tudor Edwards/Vehmehren Costotome	19

OSTEOTOMES & MALLETS

Dahmen Osteotome	20
Lexer Osteotome	20
Stille Osteotome	20
Scaglietti Osteotome Set	21
Mallets	21 & 22

ELEVATORS, GOUGES & IMPACTORS

Adson Elevator	23
Pennybacker Elevator	23
Bone Raspatory	23
Farabeuf Elevator	23
Trethowan Lever	24
Lanes Lever	24
Fagge Lever	24
Bristows Elevator	24
Hohmanns Lever	25
Inferior Hohmann Hip Retractor	25
Zielke Gouge	25
Capener Gouge	25
Cervical Impactor	26
Lumbar Impactor	26
Anterior Impactor	26
Cobb Elevators	27 & 28

SPINAL CURETTES

Bayonet Cervical Micro Curette Set	29
Karlin Style Bayonet Cervical Micro Curettes	30
Lempert Curette	31
Bruns Curette	31
Tufnol Handle Curette	31
Double Handled Curette	32
Comfort Handle Curette	32
Long Anterior Curette	32
Light-Grip Cervical Curette	33
Light-Grip Lumbar Curette	34
Cones Curette	35
Zielke Curette	35
Volkman Curette	35

DISSECTORS

Swedish Dissector	36
Howarth Elevator	36
MacDonald Elevator/Dissector	36
Watson Cheyne Dissector	36
Freers Elevator/Dissector	36

CASPAR CERVICAL DISTRACTION SET

Caspar Distraction Set	37 & 38
------------------------	---------

LAMINA SPREADERS

Cervical Vertebral Spreader	39
Cloward Cervical Spreader	39
Cloward Lamina Spreader	39
Baby Inge Lamina Spreader	40
Inge Lamina Spreader	40
Scaglietti Lamina Spreader	40
Long Anterior Lamina Spreader	40

HOOKS & PROBES

Adson Dural Hook	41
Titanium Micro Hook	41
Crile Hook	41
Emmet Hook	41
Cushing Hook	41
Adson Hook	42
McCulloch Style Probe	42
Manipulation Hook	42

HOOKS & PROBES cont.

Blalock Blunt Hook	42
Caspar Exploration Probe	42

RETRACTORS

Love Bayonet Nerve Root Retractor	43
Krayenbuhl Nerve Root Retractor	43
O'Connell Nerve Root Retractor	43
Love Nerve Root Retractor	43
Shepperd Suction Nerve Root Retractor	44
Nerve Root Retractor with Suction	44
Hess Nerve Root Retractor	44
Meyerding Retractor	45
Langenbeck Retractor	45
Taylor Retractor	45
Cloward Blade Retractor	45
Bone Hook	45
Volkman Retractor	45
Baby Weitlaner S/R Retractor	46
Mollison S/R Child Retractor	46
Mollison S/R Adult Retractor	46
Wests/Weitlaner S/R Retractor	47
Travers S/R Retractor	47
Norfolk & Norwich S/R Retractor	47
Cones S/R Retractor	48
Beckman-Adson S/R Retractor	48
Gelpi Laminectomy S/R Retractor	49
Hardman S/R Retractor	49
Meyerding S/R Retractor	49
Long Gelpi Orthopaedic S/R Retractor	50
Viper Scoliosis S/R Retractor	50
Micro Discectomy Retractor System	51 & 52
Micro Discectomy Instrument Set	53 & 54
Black Belt Cervical Retractor System	55 & 56
Super-Slide Laminectomy Retractor System	57 & 58
Caspar Retractor System	59 & 60
Black Belt Micro Discectomy Retractor Set	61

BAYONET MICRO INSTRUMENTS FOR DURAL REPAIRS

Yasargil Bayonet Micro Needle Holder	62
Bayonet Micro Needle Holder	62
Yasargil Bayonet Micro Forceps	62
Yasargil Bayonet Micro Scissors	62

BIPOLAR FORCEPS

Straight Bipolar Forceps	63
Bayonet Bipolar Forceps	63 & 64

MISC INSTRUMENTS

Slim Nose Wire Twisters	65
Orthopaedic Locking Pliers	65
Combined Wire Cutters & Pliers	65
Bolt Cutters	66
Muller-Claus Wire Cutters	66
Needle Nosed Locking Pliers	66
Measuring Caliper/Gauges	67
Suction Tubes	68
Bayonet Forceps	68



LAMINECTOMY PUNCH



Kerrison Laminectomy Punch

- 90° UPWARD Jaw angle

90° UPWARD JAW

18cm/7" Shaft	20cm/8" Shaft	Bite Size
PSKU 9071	FSKU 9081	1mm
PSKU 9072	FSKU 9082	2mm
PSKU 9073	FSKU 9083	3mm
PSKU 9074	FSKU 9084	4mm
PSKU 9075	FSKU 9085	5mm
PSKU 9076	FSKU 9086	6mm



90° UPWARD



Kerrison Laminectomy Punch

- 90° DOWNWARD Jaw angle

90° DOWNWARD JAW

18cm/7" Shaft	20cm/8" Shaft	Bite Size
PSKD 9071	PSKD 9081	1mm
PSKD 9072	PSKD 9082	2mm
PSKD 9073	PSKD 9083	3mm
PSKD 9074	PSKD 9084	4mm
PSKD 9075	PSKD 9085	5mm
PSKD 9076	PSKD 9086	6mm



90° DOWNWARD

LAMINECTOMY PUNCH

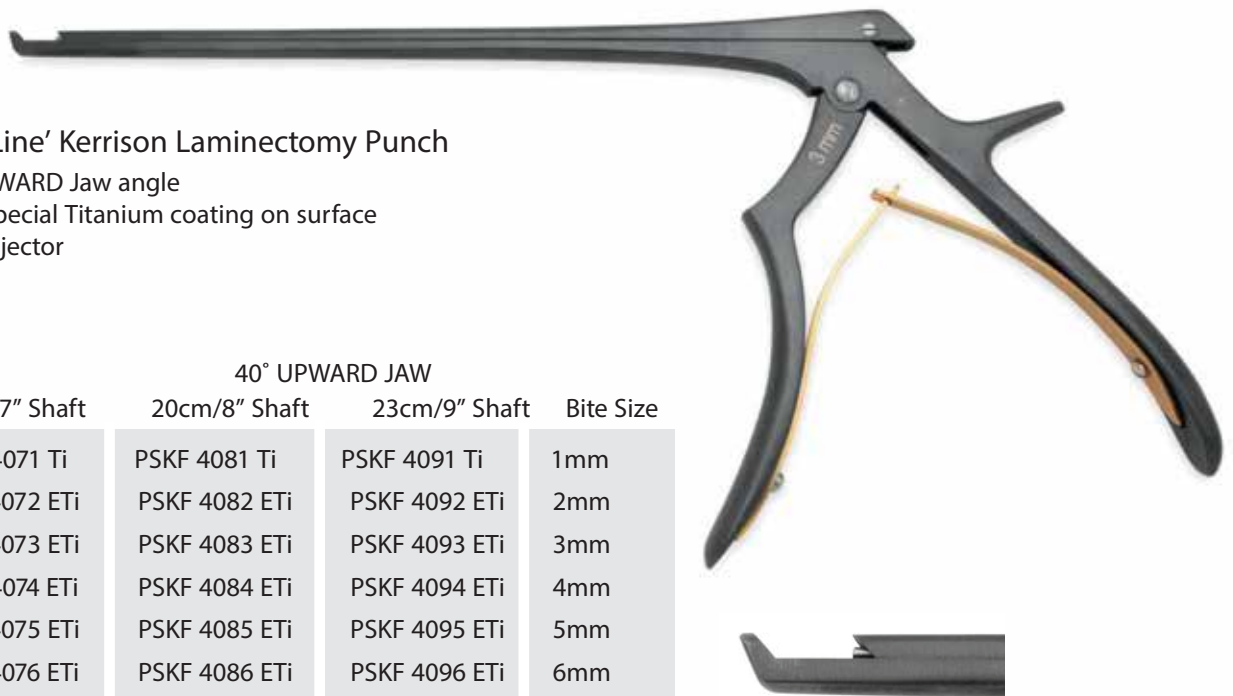

'Black Line' Kerrison Laminectomy Punch

- 40° UPWARD Jaw angle
- With special Titanium coating on surface
- Bone ejector

40° UPWARD JAW			
18cm/7" Shaft	20cm/8" Shaft	23cm/9" Shaft	Bite Size
PSKF 4071 Ti	PSKF 4081 Ti	PSKF 4091 Ti	1mm
PSKF 4072 ETi	PSKF 4082 ETi	PSKF 4092 ETi	2mm
PSKF 4073 ETi	PSKF 4083 ETi	PSKF 4093 ETi	3mm
PSKF 4074 ETi	PSKF 4084 ETi	PSKF 4094 ETi	4mm
PSKF 4075 ETi	PSKF 4085 ETi	PSKF 4095 ETi	5mm
PSKF 4076 ETi	PSKF 4086 ETi	PSKF 4096 ETi	6mm

40° UPWARD

Kerrison Laminectomy Punch with Bone Ejector

- 40° UPWARD Jaw angle
- Bone ejector

40° UPWARD JAW			
18cm/7" Shaft	20cm/8" Shaft	23cm/9" Shaft	Bite Size
PSKF 4071	PSKF 4081	PSKF 4091	1mm
PSKF 4072E	PSKF 4082E	PSKF 4092E	2mm
PSKF 4073E	PSKF 4083E	PSKF 4093E	3mm
PSKF 4074E	PSKF 4084E	PSKF 4094E	4mm
PSKF 4075E	PSKF 4085E	PSKF 4095E	5mm
PSKF 4076E	PSKF 4086E	PSKF 4096E	6mm



40° UPWARD

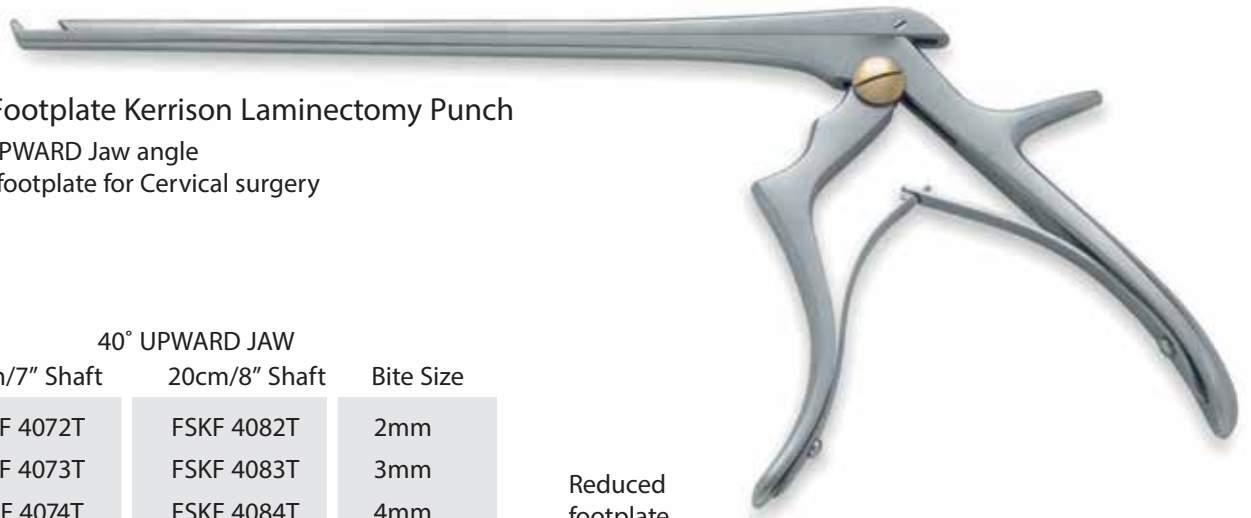

Thin Footplate Kerrison Laminectomy Punch

- 40° UPWARD Jaw angle
- Thin footplate for Cervical surgery

40° UPWARD JAW

18cm/7" Shaft	20cm/8" Shaft	Bite Size
PSKF 4072T	FSKF 4082T	2mm
PSKF 4073T	FSKF 4083T	3mm
PSKF 4074T	FSKF 4084T	4mm
PSKF 4075T	FSKF 4085T	5mm
PSKF 4076T	FSKF 4086T	6mm



40° UPWARD

- A reduced footplate thickness useful for a restricted operating area

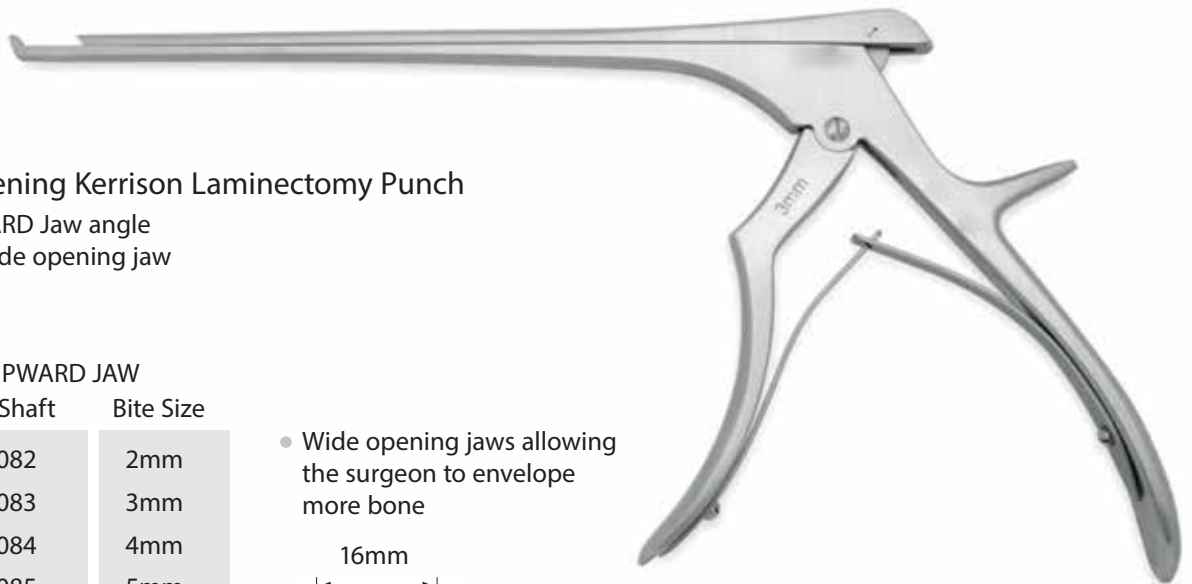

Wide Opening Kerrison Laminectomy Punch

- 40° UPWARD Jaw angle
- 16mm Wide opening jaw

40° UPWARD JAW

20cm/8" Shaft	Bite Size
PSKW 4082	2mm
PSKW 4083	3mm
PSKW 4084	4mm
PSKW 4085	5mm
PSKW 4086	6mm

- Wide opening jaws allowing the surgeon to envelope more bone

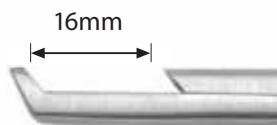

40° UPWARD

LAMINECTOMY PUNCH

'Clean Wave' Laminectomy Punch

- 40° UPWARD Jaw angle
- Open shaft for easier decontamination
- Bone ejector

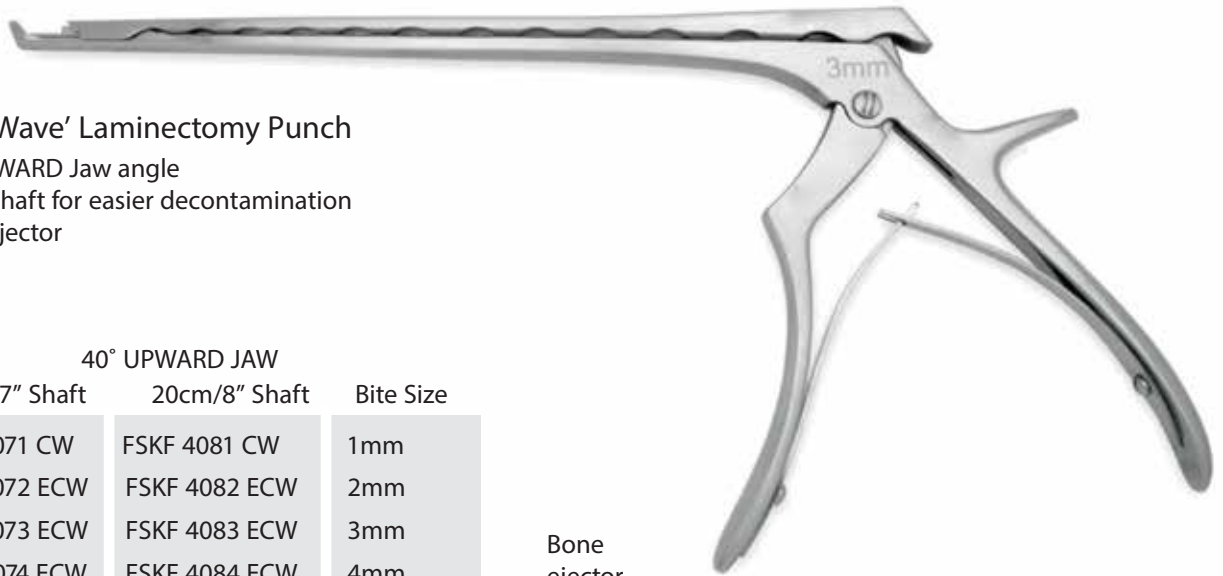

40° UPWARD JAW		Bite Size
18cm/7" Shaft	20cm/8" Shaft	
PSKF 4071 CW	FSKF 4081 CW	1mm
PSKF 4072 ECW	FSKF 4082 ECW	2mm
PSKF 4073 ECW	FSKF 4083 ECW	3mm
PSKF 4074 ECW	FSKF 4084 ECW	4mm
PSKF 4075 ECW	FSKF 4085 ECW	5mm
PSKF 4076 ECW	FSKF 4086 ECW	6mm

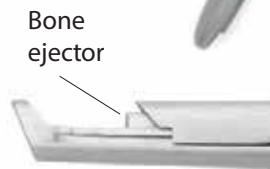

Bone ejector



40° UPWARD

- Open design of shaft allows cleaning of shaft

Love Kerrison Punch

- 40° UPWARD Jaw angle
- Oversize handle



40° UPWARD JAW	
20cm/8" Shaft	Bite Size
PSKF 4082	2mm
PSKF 4083	3mm
PSKF 4084	4mm
PSKF 4085	5mm



40° UPWARD

LAMINECTOMY PUNCH



Long Anterior Kerrison Laminectomy Punch

- 40° UPWARD Jaw angle
- With special Titanium coating on surface
- Extra long shaft for Thoracic approach
- Bone ejector

40° UPWARD JAW

28cm/11" Shaft Bite Size

PSKF 4002ETi	2mm
PSKF 4003ETi	3mm
PSKF 4004ETi	4mm
PSKF 4005ETi	5mm
PSKF 4006ETi	6mm



40° UPWARD



Curved Foramenotomy Punch

- 40° UPWARD Jaw angle
- Curved shaft designed to improve access to the Foramen

20cm/8" Shaft Bite Size

PSKC 4082	2mm
PSKC 4083	3mm
PSKC 4084	4mm



LAMINECTOMY PUNCH



Ferris-Smith Kerrison Laminectomy Punch

- 40° UPWARD Jaw angle
- Modified ring handle

40° UPWARD JAW

18cm/7" Shaft	20cm/8" Shaft	Bite Size
PSKR 4072	FSKR 4082	2mm
PSKR 4073	FSKR 4083	3mm
PSKR 4074	FSKR 4084	4mm
PSKR 4075	FSKR 4085	5mm
PSKR 4076	FSKR 4086	6mm

40° UPWARD

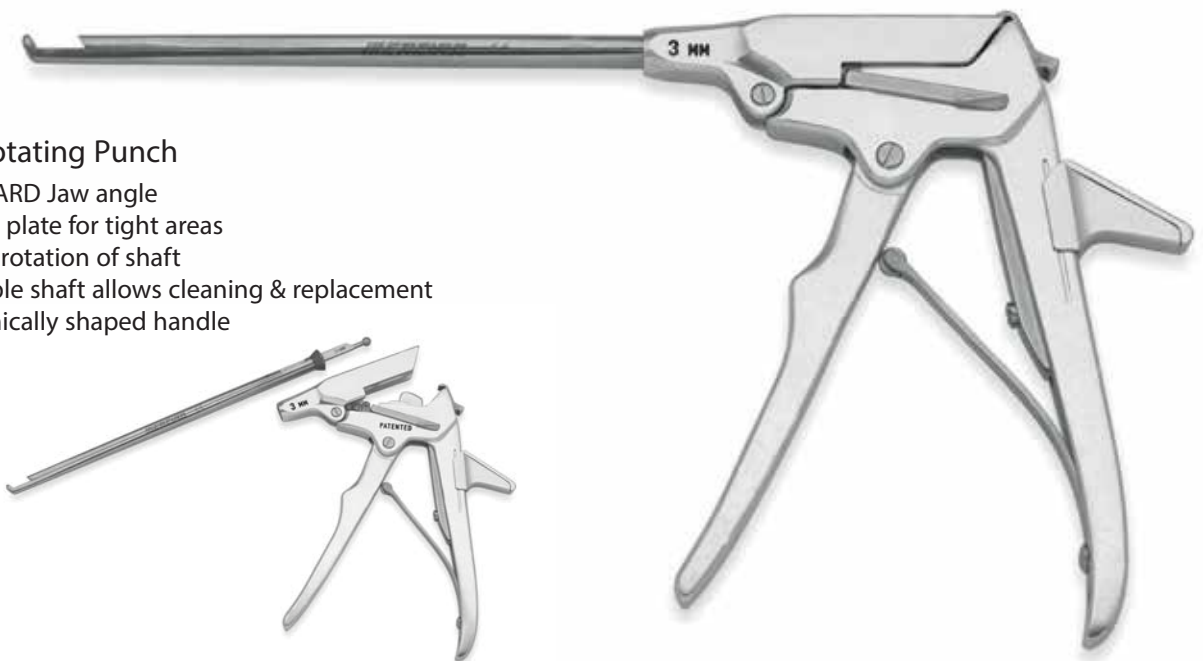

Osteo-Rotating Punch

- 40° UPWARD Jaw angle
- Thin foot plate for tight areas
- Full 360° rotation of shaft
- Removable shaft allows cleaning & replacement
- Ergonomically shaped handle

40° UPWARD JAW

18cm/7" Shaft	21cm/8 1/4" Shaft	Bite Size
PS7375 - 40	SP7376 - 40	0.6mm
PS7375 - 41	SP7376 - 41	1mm
PS7375 - 42	SP7376 - 42	2mm
PS7375 - 43	SP7376 - 43	3mm
PS7375 - 44	SP7376 - 44	4mm

DISC RONGEURS

Intervertebral Disc Rongeur



STRAIGHT JAW

15cm/6" Shaft	18cm/7" Shaft	20cm/8" Shaft	Bite Size
K6-S	K7-S	K8-S	1.5mm
C6-S	C7-S	C8-S	2mm
LG6-S	LG7-S	LG8-S	3mm
S6-S	S7-S	S8-S	4mm
R6-S	R7-S	R8-S	5mm
P6-S	P7-S	P8-S	6mm
Q6-S	Q7-S	Q8-S	7mm

Intervertebral Disc Rongeur



40° ANGLED UPWARD JAW

15cm/6" Shaft	18cm/7" Shaft	20cm/8" Shaft	Bite Size
K6-U	K7-U	K8-U	1.5mm
C6-U	C7-U	C8-U	2mm
LG6-U	LG7-U	LG8-U	3mm
S6-U	S7-U	S8-U	4mm
R6-U	R7-U	R8-U	5mm
P6-U	P7-U	P8-U	6mm
Q6-U	Q7-U	Q8-U	7mm

Intervertebral Disc Rongeur



40° ANGLED DOWNWARD JAW

15cm/6" Shaft	18cm/7" Shaft	20cm/8" Shaft	Bite Size
K6-D	K7-D	K8-D	1.5mm
C6-D	C7-D	C8-D	2mm
LG6-D	LG7-D	LG8-D	3mm
S6-D	S7-D	S8-D	4mm
R6-D	R7-D	R8-D	5mm
P6-D	P7-D	P8-D	6mm
Q6-D	Q7-D	Q8-D	7mm

Caspar Toothed Disc Rongeur



- Serrated and fenestrated jaws

STRAIGHT JAW

16cm/6 1/4" Shaft	18cm/7" Shaft	Bite Size
PS1502-16	PS1502-18	2mm
PS1503-16	PS1503-18	3mm
PS1504-16	PS1504-18	4mm
PS1505-16	PS1505-18	5mm

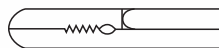

UPWARD JAW

16cm/6 1/4" Shaft	18cm/7" Shaft	Bite Size
PS1602-16	PS1602-18	2mm
PS1603-16	PS1603-18	3mm
PS1604-16	PS1604-18	4mm
PS1605-16	PS1605-18	5mm

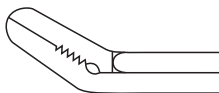

DOWNWARD JAW

16cm/6 1/4" Shaft	18cm/7" Shaft	Bite Size
PS1702-16	PS1702-18	2mm
PS1703-16	PS1703-18	3mm
PS1704-16	PS1704-18	4mm
PS1705-16	PS1705-18	5mm

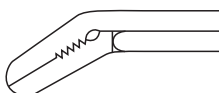

Schlesinger Toothed Rongeur

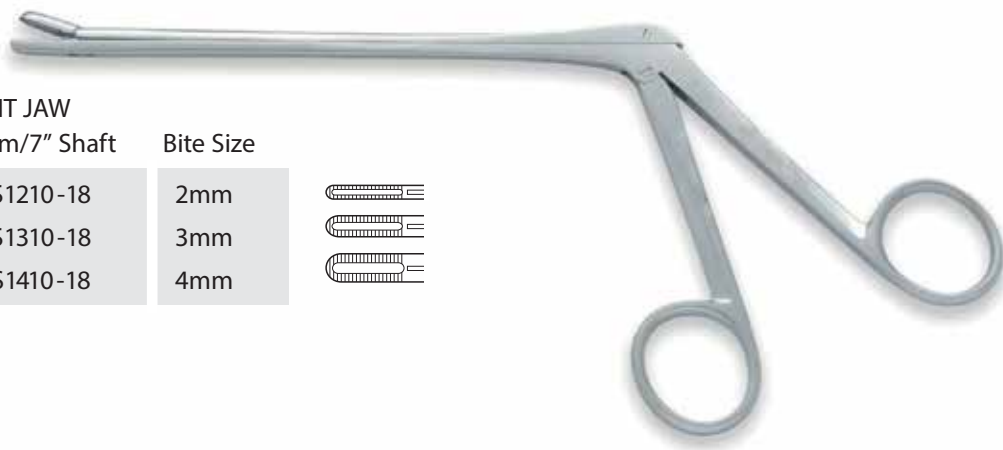

STRAIGHT JAW

15cm/6" Shaft	18cm/7" Shaft	Bite Size
PS1210-15	PS1210-18	2mm
PS1310-15	PS1310-18	3mm
PS1410-15	PS1410-18	4mm

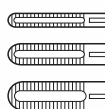

DISC RONGEURS

Williams Discectomy Rongeur

14cm/5 1/2" Shaft

PS1110-14

Longer pattern
23cm/9" Shaft

PS1110-23



- Single toothed cup 1mm bite

'Pea Pod' Disc Rongeur

- Short 10mm length jaw

15cm/6" Bite Size

PS1510-15 2mm

PS1610-15 3mm

PS1710-15 4mm



13cm/5 1/4" Bite Size

PS1510-13 2mm

Extra fine pattern 5mm length jaws

Beck Disc Rongeur

- 13cm/5 1/4" Shaft
- 2mm bite size

PS1910-13



Munich Grasping Forceps

- 18cm/7" Shaft length
- 1x2 teeth
- Straight jaw

PS1224-18



Toothed Serrated Jaw

Decker Ronguer

- 15cm/6" working length
- Straight 6mm jaw

PS1223-15



1.5mm Jaw

Nicola Micro Cupped Biopsy Forceps

- 16.5cm/6 1/2" Shaft

PS1222-16

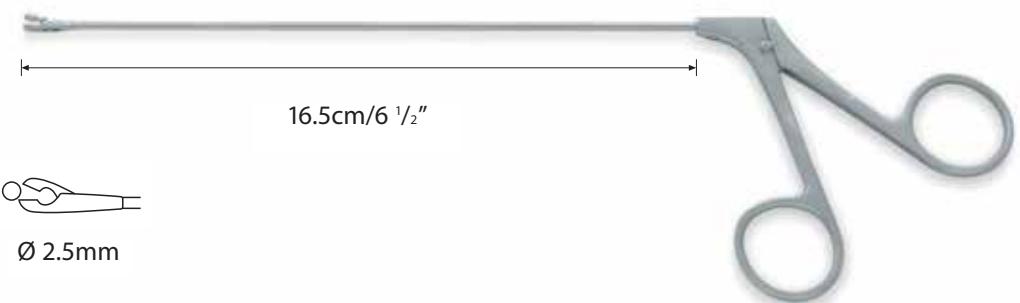

16.5cm/6 1/2"

Ø 2.5mm

'Clean Wave' Intervertebral Disc Rongeur



STRAIGHT JAW

15cm/6" Shaft	18cm/7" Shaft	20cm/8" Shaft	Bite Size
K6-SCW	K7-SCW	K8-SCW	1.5mm
C6-SCW	C7-SCW	C8-SCW	2mm
LG6-SCW	LG7-SCW	LG8-SCW	3mm
S6-SCW	S7-SCW	S8-SCW	4mm
R6-SCW	R7-SCW	R8-SCW	5mm
P6-SCW	P7-SCW	P8-SCW	6mm
Q6-SCW	Q7-SCW	Q8-SCW	7mm



- Open design of shaft allows cleaning of shaft

40° ANGLED UPWARD JAW

15cm/6" Shaft	18cm/7" Shaft	20cm/8" Shaft	Bite Size
K6-UCW	K7-UCW	K8-UCW	1.5mm
C6-UCW	C7-UCW	C8-UCW	2mm
LG6-UCW	LG7-UCW	LG8-UCW	3mm
S6-UCW	S7-UCW	S8-UCW	4mm
R6-UCW	R7-UCW	R8-UCW	5mm
P6-UCW	P7-UCW	P8-UCW	6mm
Q6-UCW	Q7-UCW	Q8-UCW	7mm

40° ANGLED DOWNWARD JAW

15cm/6" Shaft	18cm/7" Shaft	20cm/8" Shaft	Bite Size
K6-DCW	K7-DCW	K8-DCW	1.5mm
C6-DCW	C7-DCW	C8-DCW	2mm
LG6-DCW	LG7-DCW	LG8-DCW	3mm
S6-DCW	S7-DCW	S8-DCW	4mm
R6-DCW	R7-DCW	R8-DCW	5mm
P6-DCW	P7-DCW	P8-DCW	6mm
Q6-DCW	Q7-DCW	Q8-DCW	7mm

Ferris-Smith Disc Rongeur

- Ring handle

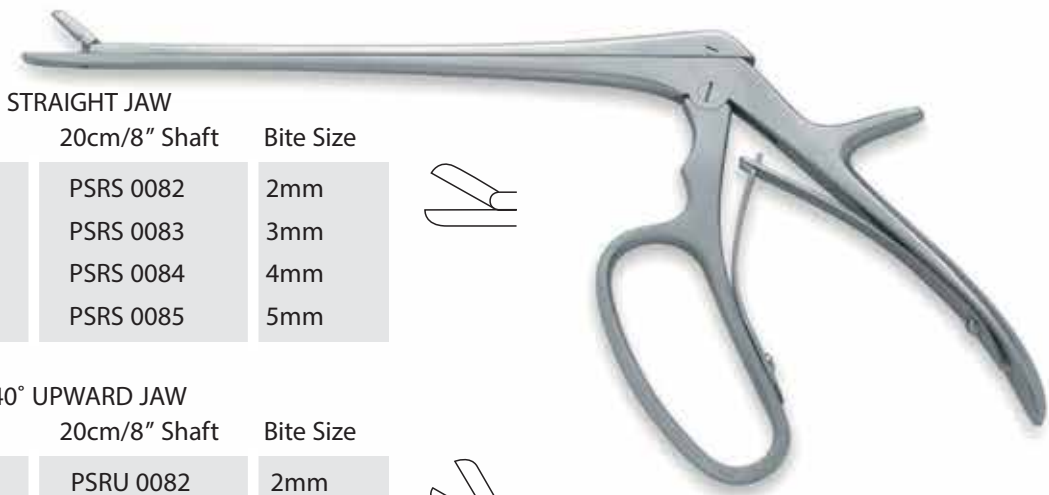

STRAIGHT JAW

18cm/7" Shaft	20cm/8" Shaft	Bite Size
PSRS 0072	PSRS 0082	2mm
PSRS 0073	PSRS 0083	3mm
PSRS 0074	PSRS 0084	4mm
PSRS 0075	PSRS 0085	5mm

40° UPWARD JAW

18cm/7" Shaft	20cm/8" Shaft	Bite Size
PSRU 0072	PSRU 0082	2mm
PSRU 0073	PSRU 0083	3mm
PSRU 0074	PSRU 0084	4mm
PSRU 0075	PSRU 0085	5mm

Anterior Disc Rongeur

- 28cm/11" Shaft
- Longer 28cm shaft for greater reach in the Anterior approach



Straight	Upward	Bite Size
A11S-2	A11U-2	2mm
A11S-3	A11U-3	3mm
A11S-4	A11U-4	4mm
A11S-5	A11U-5	5mm

Anterior Long Rongeur

- 35cm/13 1/2" Shaft
- Extra long length shaft for deeper areas

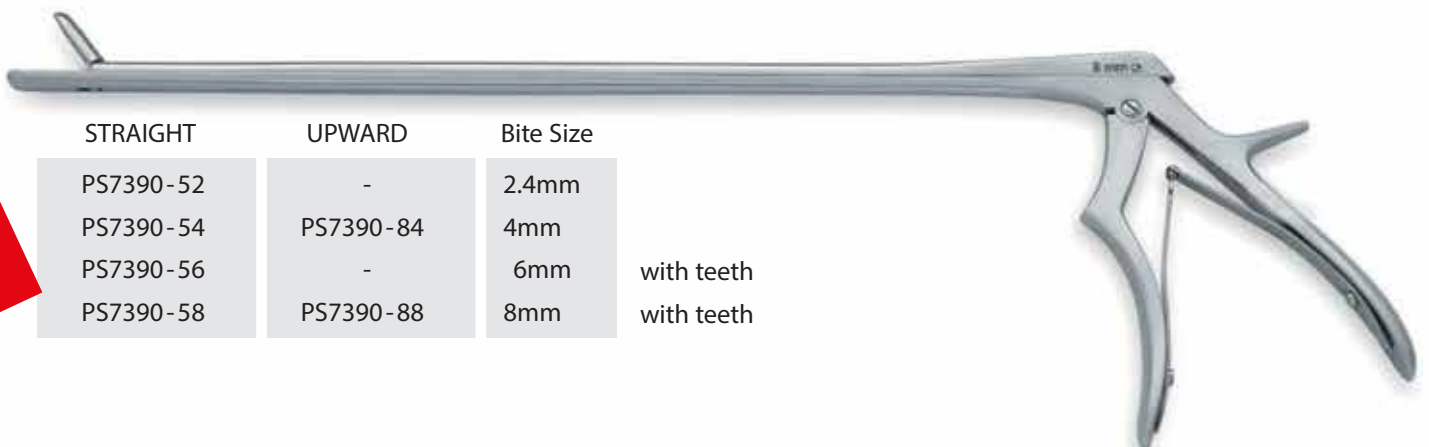

STRAIGHT	UPWARD	Bite Size	
PS7390-52	-	2.4mm	
PS7390-54	PS7390-84	4mm	
PS7390-56	-	6mm	with teeth
PS7390-58	PS7390-88	8mm	with teeth

BONE NIBBLERS & CUTTERS

Lempert Bone Nibbler

- Single Action
- 19cm/7 1/2"

3mm Bite
PS1001-19



Luer Bone Nibbler

- Single Action
- 18cm/7"



Straight
8mm Bite
PS1004-18



Curved
8mm Bite
PS1005-18



Adsons Bone Nibbler

- Single Action
- 20cm/8"



7mm Bite
PS1040-20

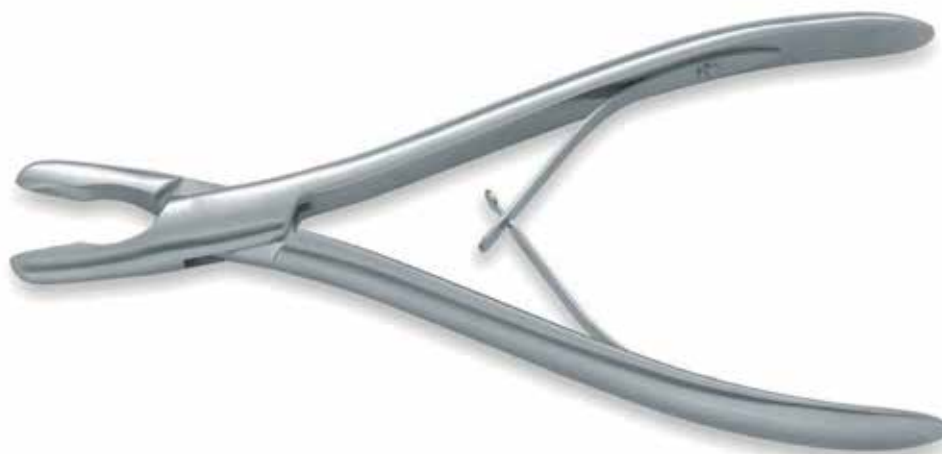

BONE NIBBLERS & CUTTERS

Pennybacker Bone Nibbler

- Single Action
- 20cm/8"



4mm Bite

PS1041-20



Northfields Bone Nibbler

- Single Action
- 20cm/8"

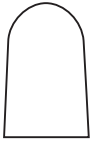

10mm Bite

PS1042-20



'Rat Toothed' Bone Nibbler

- Single Action
- 21cm/8 1/4"

8mm Bite

PS1030-21



- 3 x 3 Teeth

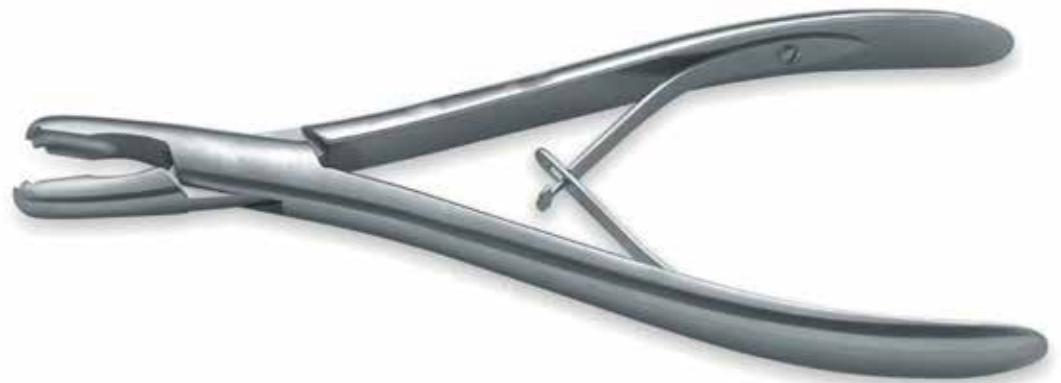

BONE NIBBLERS & CUTTERS

Zielke Intervertebral Rongeur

- Angled Parallel Jaws



21cm/8 1/4" 25cm/9 3/4" Bite Size

PS1026-21

SP1026-25

3mm

PS1027-21

SP1027-25

5mm

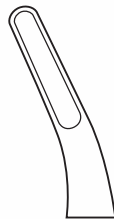

3mm Bite

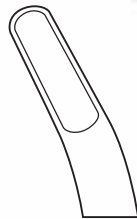

5mm Bite

Matzen Intervertebral Rongeur

- 20cm/8"
- Angled Jaws

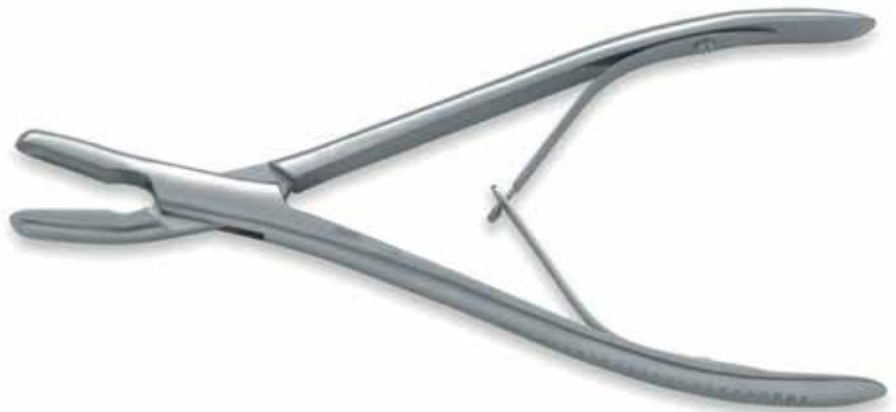

8mm Bite

PS1043-20

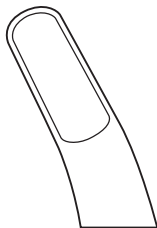

Beyer Bone Nibbler

- Curved Double Action
- 18cm/7"



4mm Bite

PS1002-18

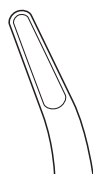

BONE NIBBLERS & CUTTERS

Jansen Bone Nibbler

- Curved Double Action
- 18cm/7"

5mm Bite
PS1003-18

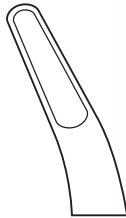

Marquardt Bone Nibbler

- Curved Double Action
- 20cm/8"

3mm Bite
PS1002-20

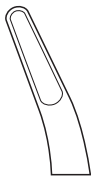

Smith-Peterson Bone Nibbler

- Double Action
- 24cm/9 1/2"



Straight

Light Curve

Bite Size

PS1010-24

PS1014-24

3mm

PS1011-24

PS1015-24

4mm

PS1012-24

PS1016-24

5mm

PS1013-24

PS1017-24

6mm



Straight

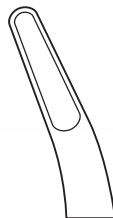

Light Curve

BONE NIBBLERS

Stille-Luer Bone Nibbler

- Double Action
- 22cm/8 3/4"

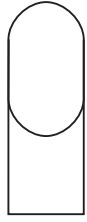

Straight
10mm Bite
PS1006-22



Curved
10mm Bite
PS1007-22



'Mr Blobby' Stille-Luer Bone Nibbler

- Double Action
- 26cm/10 1/4"

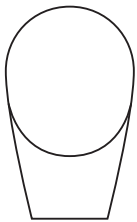

Straight
17mm Bite
PS1008-26



Curved
17mm Bite
PS1009-26



Leksell Bone Nibbler

- Double Action Angled
- 24cm/9 1/2"

Angled Jaw Bite Size

PS1018-24

3mm

PS1019-24

5mm

PS1020-24

8mm



3mm



5mm



8mm



BONE NIBBLERS

Echlin Duckbill Nibbler

- Double Action
- 23cm/9"

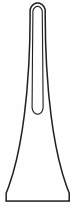

2mm Bite

PS1044-23



3mm Bite

PS1045-23



4mm Bite

PS1046-23

Long Anterior Leksell Bone Nibbler

- Double Action
- 30cm/12"

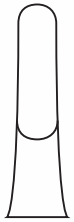

5mm Bite

PS1021-30



8mm Bite

PS1022-30

Sypert Bone Nibbler

- Double Action - very long
- 36cm/14 1/4"



5mm Bite

PS1031-36



8mm Bite

PS1032-36

BONE CUTTERS

McIndoe Bone Cutters

- 18cm/7"



PS1028-18



Stille-Liston Bone Cutters

- 27cm/10 3/4"



Straight

PS1024-27



Angled

PS1025-27



Liston-Key-Horsley Bone Cutters

- 27cm/10 3/4"



PS1023-27



Tudor Edwards/Vehmehren Costotome

- 24cm/9 1/2"
- For cutting ribs

PS1023-24



OSTEOTOMES

Dahmen Tufnol Handle Osteotome

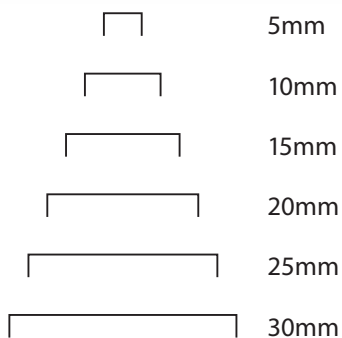

Straight	Width
PS7105-30	5mm
PS7110-30	10mm
PS7115-30	15mm
PS7120-30	20mm
PS7125-30	25mm
PS7130-30	30mm



Angled	Width
PS7305-30	5mm
PS7310-30	10mm
PS7315-30	15mm
PS7320-30	20mm
PS7325-30	25mm
PS7330-30	30mm

Lexer Tufnol Handle Osteotome

• 22cm/8 3/4"

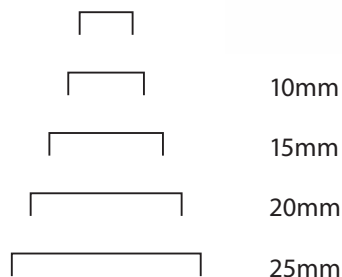

Width	
PS7207-22	7mm
PS7210-22	10mm
PS7215-22	15mm
PS7220-22	20mm
PS7225-22	25mm

Stille Osteotome

• 20cm/8"

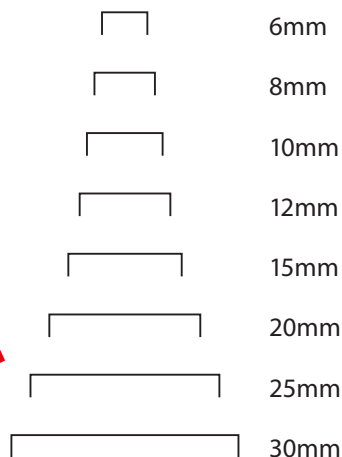

Width	
PS7706-20	6mm
PS7708-20	8mm
PS7710-20	10mm
PS7712-20	12mm
PS7715-20	15mm
PS7720-20	20mm
PS7725-20	25mm
PS7730-20	30mm

Scaglietti Straight Osteotome Set

PS7452-00

Complete set consisting of:

Qty	Order Code	Description
5		Scaglietti Osteotomes - 5 sizes
1	PS7420-90	Instrument Case



Scaglietti Osteotomes

- 26cm/10 1/4"

Size

PS7452-06	6mm
PS7452-09	9mm
PS7452-12	12mm
PS7452-16	16mm
PS7452-19	19mm



Toffee Mallet

- 19cm/7 1/2"
- Head size 22mm Ø
- Weight 165g/6oz

PS5808-21



London Splint Mallet

- 18cm/7"
- Head size 30mm Ø
- Weight 450g/16.2oz

PS5802-18



MALLETS

Heath Mallet

- 19cm/7 1/2"
- Stainless steel head
- Head size 40mm Ø
- Weight 1020g/36oz

PS5809-19



Mallet with Tufnol Handle

- 23cm/9"
- Head size 35mm Ø
- Weight 550g/20oz

PS5804-23



Ombredanne Mallet

- 24cm/9 1/2"
- Head size 40mm Ø
- Weight 550g/20oz

PS5806-24



Tufnol Mallet

- 25.5cm/10"
- Head size 42mm Ø
- Weight 250g/10oz

PS5807-25



ELEVATORS & GOUGES

Adson Periosteal Elevator

- 16cm/6 1/4"
- Curved blunt



	Width
SP3055-16	5mm
SP3007-16	7mm

Pennybacker Periosteal Elevator

- 16cm/6 1/4"
- Curved sharp



	Width
PS3064-16	4mm
SP3066-16	6mm
SP3068-16	8mm

Bone Raspatory with Tufnol Handle

- 19cm/7 1/2"

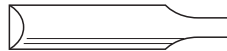

Straight	Width	
PS7016-19	6mm	

Curved	Width	
PS7023-19	3mm	
PS7026-19	6mm	

Farabeuf Rugine Elevator

- 15cm/6"



Straight	Width
PS3001-15	12mm

Curved*	Width
PS3002-15	12mm

*illustrated

ELEVATORS & GOUGES

Trethowan Bone Lever

- 22.5cm/8 1/2"



SP3030-22

Lanes Bone Lever

- 26cm/10 1/4"



PS3031-26

Fagge Bone Lever

- 27.5cm/10 3/4"



PS3032-27

Bristows Bone Elevator

- 23cm/9"
- Curved sharp



Width

PS3003-23

10mm

Hohmanns Bone Elevator

- 24cm/9 1/4"



	Width
PS3008-22	8mm
PS3018-24	18mm
PS3043-24	43mm

Inferior Hohmann Hip Retractor

- 40cm/16"
- 22mm width

PS3022-40

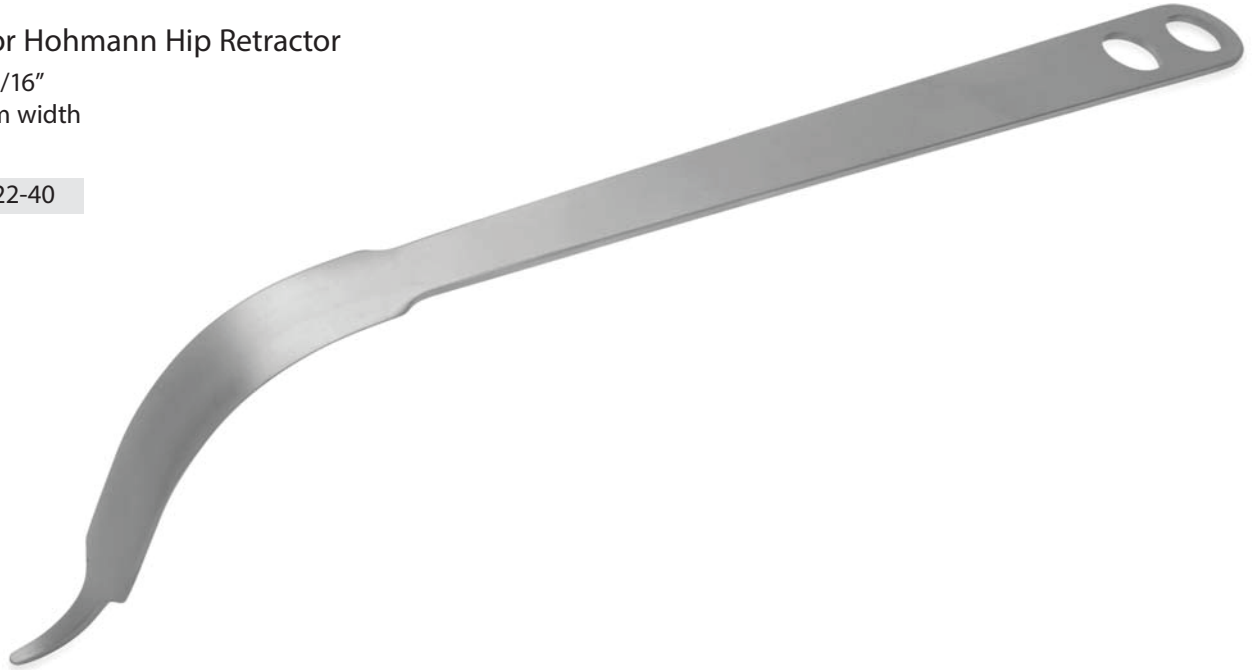

Zielke Gouge

- 23cm/9"

*illustrated



Curved*	Width
PS6520-23	6mm
PS6521-23	9mm



S-Shaped	Width
PS6522-23	6mm
PS6523-23	9mm

Capener Lamina Gouge

- 23cm/9"
- Cranked Shaft



	Width
PS6506-23	6mm
PS6508-23	8mm
PS6511-23	11mm
PS6516-23	16mm

BONE GRAFT IMPACTORS

Cervical Bone Graft Impactor 90° Offset

• 22cm/8 1/2"

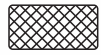

6mm x 12mm Tip

PS7222-10

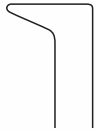

3.5mm x 6mm Tip

PS7222-55

18cm length



Lumbar Bone Graft Impactor

• 22cm/8 1/2"

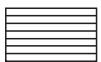

7mm x 12mm

PS7222-40

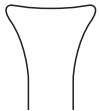

10mm x 13mm

PS7222-50



Anterior Bone Graft Impactor

• 34cm/13 1/2"



9 x 16mm Tip

PS7439-48

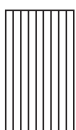

9 x 23mm Tip

PS7439-50

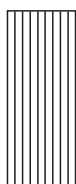

COBB ELEVATORS

Cobb Spinal Elevator

- 31cm/12 1/4" overall length
- 18cm/7" handle length



10mm

PS7561-10



13mm

PS7561-13



19mm

PS7561-19



Harrington Cobb Spinal Elevator

- 30.5cm/12" overall length



10mm

PS7661-10



13mm

PS7661-13



19mm

PS7661-19



Cobb Spinal Elevator Extra Long Handle

- 34cm/13 1/2" overall length
- 22cm/8 3/4" handle length



10mm

PS7662-10



15mm

PS7662-15



20mm

PS7662-20

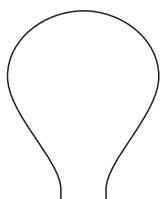

25mm

PS7662-25

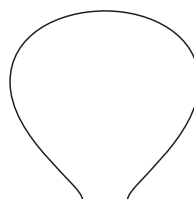

30mm

PS7662-30

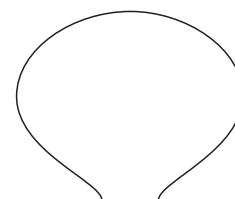

COBB ELEVATORS

Comfort Cobb Elevator

- 32cm/12 1/2" overall length
- 20cm/8" handle length



10mm

PS7551-10



15mm

PS7551-15



20mm

PS7551-20

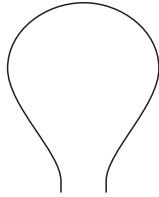

25mm

PS7551-25

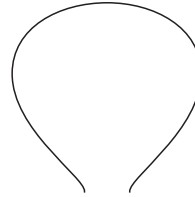

30mm

PS7551-30

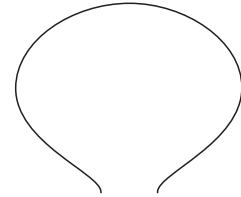

Long Anterior Comfort Cobb Elevator

- 47cm/18 1/2"



10mm

PS7551-50



15mm

PS7551-55



20mm

PS7551-60

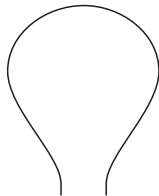

25mm

PS7551-65

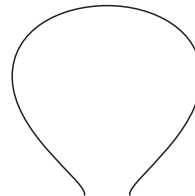

30mm

PS7551-70

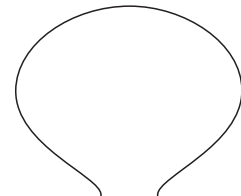

BAYONET CERVICAL MICRO CURETTES

Cervical Micro Discectomy
Curette Set

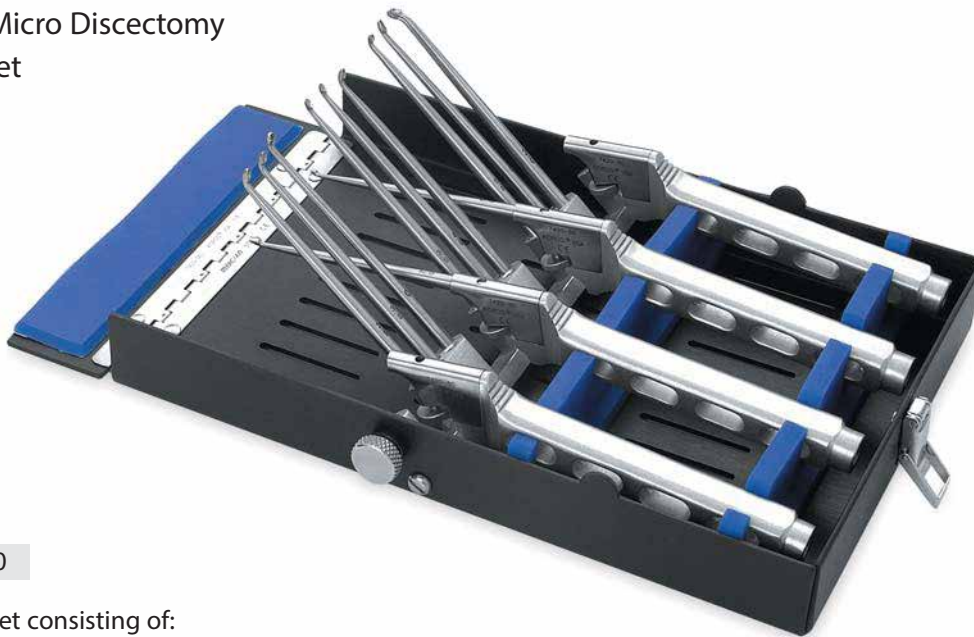

SP7420-00

Complete set consisting of:

Qty	Order Code	Description
4	PS7420-80	Curette Handles
12		Cervical Curette Shafts - includes: 5 Straight Shafts/5 Angled Shafts/2 Down Pushing Shafts
1	PS7420-90	Sterilizing Case



Slim Micro Discectomy Curette Handle

SP7420-80

- Bayonet handled design for improved visualisation
- 360° rotating shafts are interchangeable
- Shaft length is adjustable
- Lightweight handle
- Instrument length: 23cm max. for standard curettes
- Shaft length 10cm

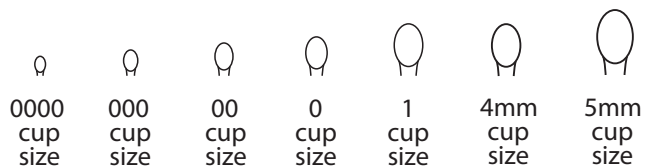

Shaft Sizes

Straight Cup	Cup Size	Forward Angle	Cup Size	Down Pushing	Cup Size
PS7420-50	00000	PS7422-50	00000	PS7424-20	00
PS7420-40	0000	PS7422-40	0000	PS7424-10	0
PS7420-30	000	PS7422-30	000		
PS7420-20	00	PS7422-20	00		
PS7420-10	0	PS7422-10	0		

KARLIN STYLE BAYONET CERVICAL MICRO CURETTES



Bayonet Cervical Curette

- 21.5cm/8 1/2" overall length
- 9cm/3 1/2" shaft length

Straight Cup	Forward Angled	Cup Size
PS7418-10C	PS7418-12C	0
PS7418-20C	PS7418-22C	00
PS7418-30C	PS7418-32C	000
PS7418-40C	PS7418-42C	0000

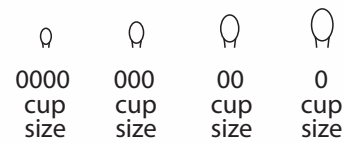

Long Bayonet Cervical Curette

- 24cm/9 1/2" overall length
- 12cm/4 3/4" shaft length

Straight Cup	Forward Angled	Cup Size
PS7418-10CL	PS7418-12CL	0
PS7418-20CL	PS7418-22CL	00
PS7418-30CL	PS7418-32CL	000
PS7418-40CL	PS7418-42CL	0000

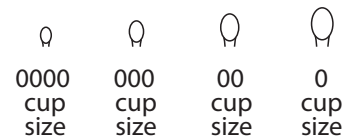

Container for 12 curettes

PS7418-98

SPINAL CURETTES

Lempert Curette

• 21cm/8 1/4"

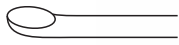

Straight	Cup Size	Angled	Cup Size
PS8010-21	00000	SP8110-21	00000
PS8015-21	0000	SP8115-21	0000
PS8020-21	000	SP8120-21	000
PS8025-21	00	SP8125-21	00
PS8030-21	0	SP8130-21	0
PS8040-21	1	SP8140-21	1

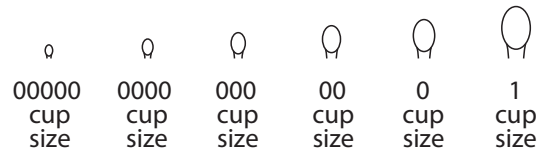

Bruns Curette

• 23cm/9"

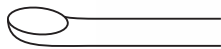

Straight	Cup Size	Angled	Cup Size
PS8220-23	000	SP8320-23	000
PS8225-23	00	SP8325-23	00
PS8230-23	0	SP8330-23	0
PS8240-23	1	SP8340-23	1
PS8250-23	2	SP8350-23	2
PS8260-23	3	SP8360-23	3

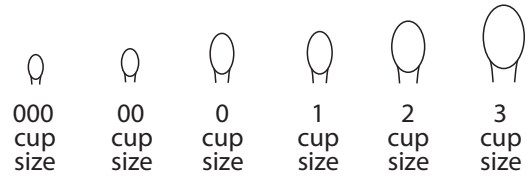

Tufnol Handle Micro Curette

• 27cm/10"



Straight	Cup Size	Angled	Cup Size
PS8010-27	0000	SP8110-27	0000
PS8020-27	000	SP8120-27	000
PS8030-27	00	SP8130-27	00
PS8040-27	0	SP8140-27	0
PS8050-27	1	SP8150-27	1

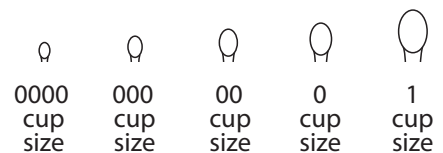

SPINAL CURETTES

Double Handled Extra Large Curette

- 38cm/15" overall length
- 21cm/8 3/4" handle length

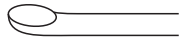

Straight Cup Size

Angled Cup Size

PS8807-34	7mm	PS8907-34	7mm
PS8809-34	9mm	PS8909-34	9mm
PS8811-34	11mm	PS8911-34	11mm
PS8813-34	13mm	PS8913-34	13mm
PS8815-34	15mm	PS8915-34	15mm

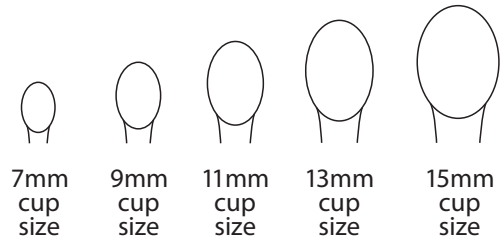

Comfort Handle Curette

- 29cm/11 1/2" overall length
- 20cm handle length



Straight Cup Size

Angled Cup Size

PS7561-07	6.5mm	PS7563-07	6.5mm
PS7561-09	8.5mm	PS7563-09	8.5mm
PS7561-11	11mm	PS7563-11	11mm
PS7561-13	13mm	PS7563-13	13mm
PS7561-15	15mm	PS7563-15	15mm

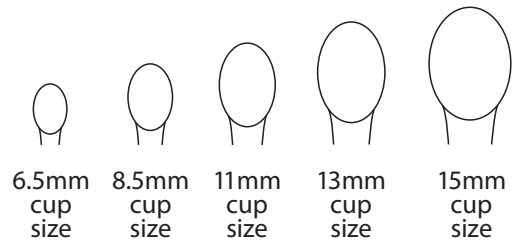

Long Anterior Curette

- 38cm/15" overall length

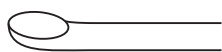

Straight Cup Size

Angled Cup Size

PS8043-38	4.3mm	PS8143-38	4.3mm
PS8070-38	7mm	PS8170-38	7mm
PS8080-38	8mm	PS8180-38	8mm

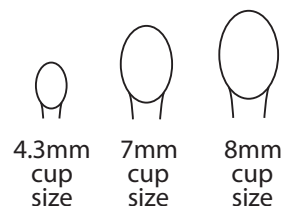

SPINAL CURETTES

Light-Grip Cervical Curettes

- 26cm/10 1/4" overall length
- 13cm/5 1/4" handle length
- Colour coded handles



Cup Size	Straight	Forward	Down
6-0	PS7403-06	PS7405-06	PS7406-06
5-0	PS7403-05	PS7405-05	PS7406-05
4-0	PS7403-04	PS7405-04	PS7406-04
3-0	PS7403-03	PS7405-03	PS7406-03
2-0	PS7403-02	PS7405-02	PS7406-02
0	PS7403-01	PS7405-01	PS7406-01
1	PS7403-10	PS7405-10	PS7406-10
2	PS7403-20	PS7405-20	PS7406-20
3	PS7403-30	PS7405-30	PS7406-30
4	PS7403-40	PS7405-40	PS7406-40
5	PS7403-50	PS7405-50	PS7406-50
6	SP7403-60	PS7405-60	PS7406-60

Light-Grip Cervical Curette Rack
Holds 12 Cervical Curettes

PS7404-90

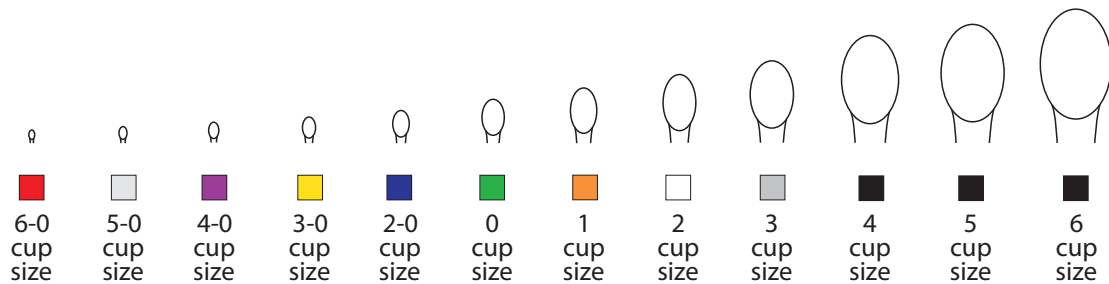

SPINAL CURETTES

Light-Grip Lumbar Currettes

- 34cm/13 1/2" overall length
- 20cm/8" handle length
- Colour coded handles



Cup Size	Straight	Forward	Down
6-0	PS7407-06	PS7408-06	PS7409-06
5-0	PS7407-05	PS7408-05	PS7409-05
4-0	PS7407-04	PS7408-04	PS7409-04
3-0	PS7407-03	PS7408-03	PS7409-03
2-0	PS7407-02	PS7408-02	PS7409-02
0	PS7407-01	PS7408-01	PS7409-01
1	PS7407-10	PS7408-10	PS7409-10
2	PS7407-20	PS7408-20	PS7409-20
3	PS7407-30	PS7408-30	PS7409-30
4	PS7407-40	PS7408-40	PS7409-40
5	PS7407-50	PS7408-50	PS7409-50
6	PS7407-60	PS7408-60	PS7409-60

Light-Grip Lumbar Curette Rack
Holds 12 Lumbar Currettes

PS7407-90

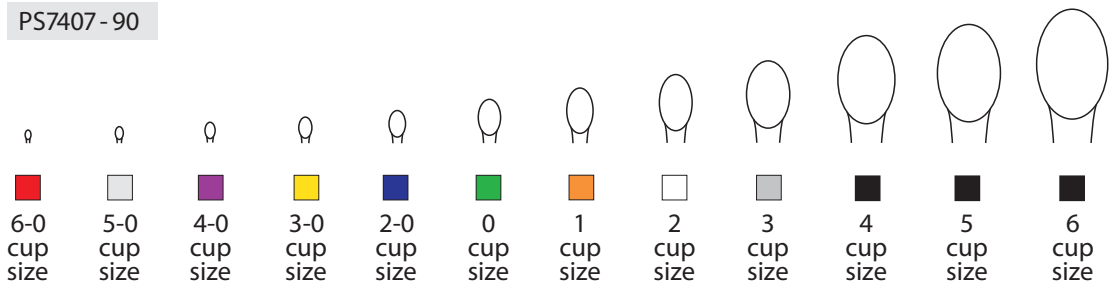

SPINAL CURETTES

Cones Ring Curette

• 23cm/9"



Straight	Ring Size	Angled	Ring Size		
PS8803-23	3mm	PS8903-23	3mm	○	3mm ring size
PS8806-23	6mm	PS8906-23	6mm	○	6mm ring size
PS8808-23	8mm	PS8908-23	8mm	○	8mm ring size

Zielke Curette

• 21cm/8 1/4"



Straight	Size	Angled	Size
PS8608-21	8mm	PS8708-21	8mm
PS8611-21	11mm	PS8711-21	11mm

Volkman Double Ended Curette

• 22cm/8 3/4"



	Size			
PS8401-22	Small	○	○	○
PS8402-22	Medium	○	○	○
PS8403-22	Large	○	○	○
		Small	Medium	Large

DISSECTORS

Swedish Dissector

- 18cm/7"



PS9201 -18

Howarth Elevator

- 21.5cm/8 1/2"



PS9207-21

MacDonald Elevator/Dissector



Size

PS7105 -19

18cm/7"

PS9206 -23

23cm/9"

Watson Cheyne Dissector



Size

HA7203 -18

18cm/7"

PS9203 -23

23cm/9"

PS9203 -25

25.5cm/10"

Freers Elevator/Dissector

- 18.5cm/7 1/4"



PS7602 -18

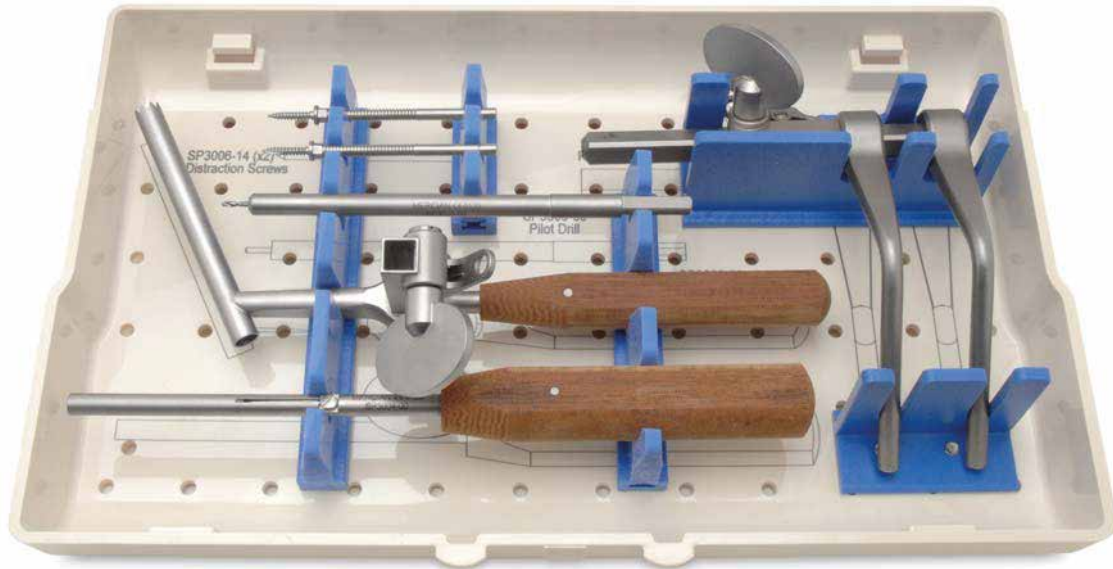

Caspar Vertebral Body Distraction Set

SP3001-00

- For retraction of the vertebral body in the cervical spine to allow access to the disc
- Less instrumentation in the disc space
- Distraction screws are secured into the vertebral body either side of the disc, the retractor is then slid over the screws and retracted

Complete set consisting of:

Qty	Order Code	Description
1	PS3002-00	Retractor Right
1	PS3003-00	Drill Guide Right
1	PS3004-00	Screw Driver
1	PS3005-00	Distraction Drill
1	PS3006-14	Sterile Distraction Screws 14mm Boxes of 10

Distraction Retractor

PS3002-00 Right (illustrated)

PS3002-10 Left



Drill Guide

PS3003-00 Right (illustrated)

PS3003-10 Left



Screw Driver

PS3004-00



Distraction Drill

PS3005-00



- For pre-drilling pilot holes for screws with drill guide 2mm

Distraction Screws

- 7cm post length
- Sterile packed



	Thread length
PS3006-12	12mm
PS3006-14	14mm
PS3006-16	16mm

Cervical Vertebral Spreader

- 13cm/5 1/4"
- 3mm tip

	Depth	
PS2002-70	70mm	
PS2002-95	95mm	*



Cloward Cervical Spreader

- 17cm/6 3/4"
- Max opening 20mm

PS2003-17



Cloward Lamina Spreader

- 15cm/6"

PS2004-70



Baby Inge Lamina Spreader

- 18cm/7"

PS5134-18

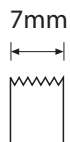

Inge Lamina Spreader

- 24cm/9 1/2", Max opening 50mm

PS2006-24

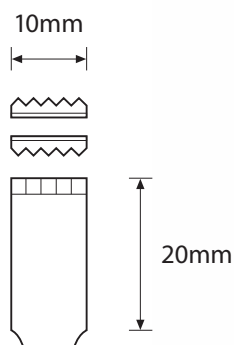

Scaglietti Lamina Spreader

- 28cm/11"
- With speed lock

PS2009-28



Long Anterior Lamina Spreader

- 28cm/11"
- Max opening 40mm

PS2008-28



Adson Dural Hook

- 19cm/7 1/2"

Sharp
SP9103-19

Blunt
SP9104-19



Titanium Micro Hooks

- 19cm/7 1/2"



90° Semi-sharp
PS8109-19



90° Blunt
MV8110-19



Crile Blunt Hook

- 20cm/8"
- 7mm tip length



PS9111 - 20

Emmet Sharp Hook

- 22cm/8 3/4"
- 5mm tip length



PS9106 - 22

Cushing Blunt Hook

- 28cm/11"
- 4mm tip length



PS9107 - 28

Adson Hook

- 20cm/8"
- 5mm tip length



McCulloch Probe with Ball End

- 23.5cm/9 1/4"



Manipulation Hook

- 23.5cm/9 1/4"
- 4mm tip length



Blalock Blunt Hook

- 24cm/9 1/2"
- 5mm tip length



Caspar Exploration Probe

- 24.5cm/9 3/4"
- Insulated shaft

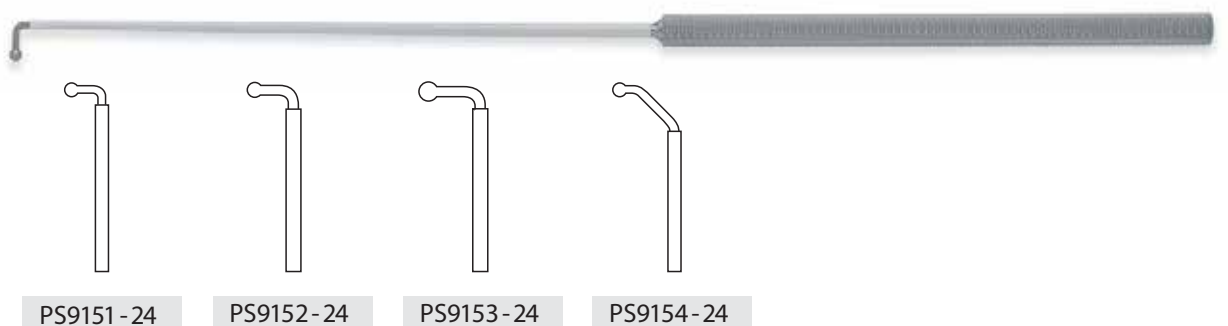

NERVE ROOT RETRACTORS

Love Bayonet Nerve Root Retractor

- 21cm/8 1/4"



PS5000-21

Krayenbuhl Nerve Root Retractor

- Double bayonet
- 21cm/8 1/4"



21cm/8 1/4" PS5041-21

24cm/9 1/2" PS5042-24

O'Connell Nerve Root Retractor

- 21.5cm/8 1/2"

PS5002-21



Love Nerve Root Retractor

- 22cm/8 3/4"
- 5mm tip width



PS5010-22

Straight

PS5011-22

25° Angled

*illustrated

PS5012-22

90° Angled

NERVE ROOT RETRACTORS

Sheppard Suction Nerve Root Retractor

- 26cm/10 1/2"
- With suction aspiration
- Fibre optic illumination
- 4mm tip width

PS5015-26

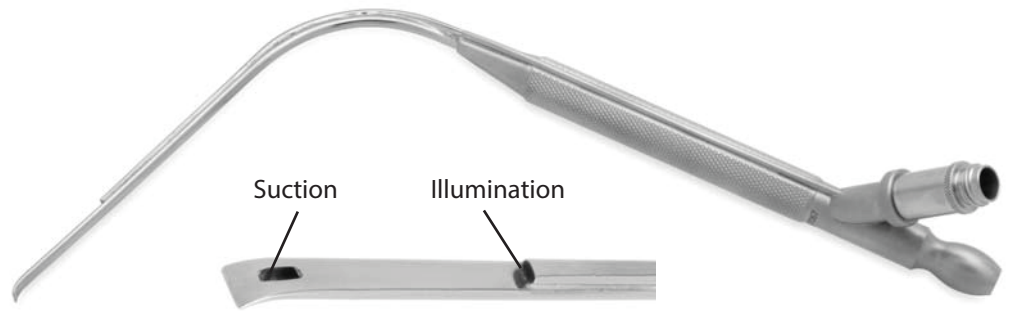

Nerve Root Retractor with suction

- 31cm/12"
- 7mm tip width

PS5013-31



Hess Nerve Root Retractor

- 19cm/7 1/2"

	Width
PS5003-19	3mm
PS5004-19	4mm
PS5005-19	5mm
PS5007-19	7mm

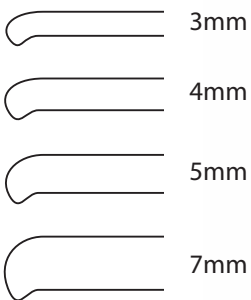

Nerve Root Retractor

19cm/7 1/2"
with fibre optic illumination



	Width
PS5033-19	3mm
PS5055-19	5mm

HAND HELD RETRACTORS

Meyerding Retractor

- 22.5cm/9"



Blade size

PS5050-22	50mm x 16mm
PS5075-22	75mm x 25mm
PS5090-22	90mm x 50mm

Langenbeck Retractor

- 21.5cm/8 1/2"



Blade size

PS5122-21	22mm x 6mm
PS5145-21	45mm x 13mm
PS5165-21	65mm x 25mm
PS5190-21	90mm x 20mm

Taylor Hip Retractor

- 19cm/7 1/2"



Depth

PS5006-19	70mm
PS5008-19	85mm
PS5010-19	100mm

Bone Hook

- 24.5cm/9 3/4"
- Sharp

PS9050-24



Volkman Catspaw Retractor

- Semi sharp teeth
- 21.5cm/8 1/2"



15 x 15mm
3 Prong

PS5015-21



15 x 20mm
4 Prong

PS5020-21

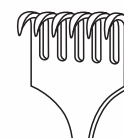

15 x 30mm
6 Prong

PS5030-21



Cloward Style Blade Retractor

- 11cm/4 1/4"

Width

PS5013-11	13mm
PS5018-11	18mm
PS5020-11	20mm



SELF RETAINING RETRACTORS

Baby Weitlaner S/R Retractor

- 11.5cm/4 1/2"
- 2 x 3 Blunt Prongs

PS5701-10



Mollison S/R Retractor - Child

- 13cm/5 1/4"
- 2 x 2 Sharp prongs 12mm depth

PS4005-13



Mollison S/R Retractor - Adult

- 17cm/6 3/4"
- 4 x 4 Sharp prongs 14mm depth

PS4005-17



SELF RETAINING RETRACTORS

West's S/R Retractor

- 14cm/5 1/2"
- 3 x 4 Sharp Prongs

PS4003-14



Weitlaner S/R Retractor

- 14cm/5 1/2"
- 3 x 4 Blunt Prongs

PS4002-14

Travers S/R Retractor

- 20cm/8"
- 4 x 5 Blunt Prongs

PS4004-20



Norfolk and Norwich S/R Retractor

- 20cm/8"
- 4 x 5 Blunt Prongs

PS4000-20



SELF RETAINING RETRACTORS

Cones Self Retaining Retractor

- 3 x 4 Prongs
- Jointed Arms



Blunt Prongs	Length
--------------	--------

PS4064-13	13cm/5"
PS4066-16	16cm/6 1/2"
PS4068-20	20cm/8"
PS4070-24	24cm/9 1/2"

Sharp Prongs	Length
--------------	--------

PS4063-13	13cm/5"
PS4065-16	16cm/6 1/2"
PS4067-20	20cm/8"
PS4069-24	24cm/9 1/2"

Beckman - Adson Retractor

- 31cm/12"
- 4 x 5 Blunt Prongs
- Jointed Arms

PS4001-32 32mm Deep blades

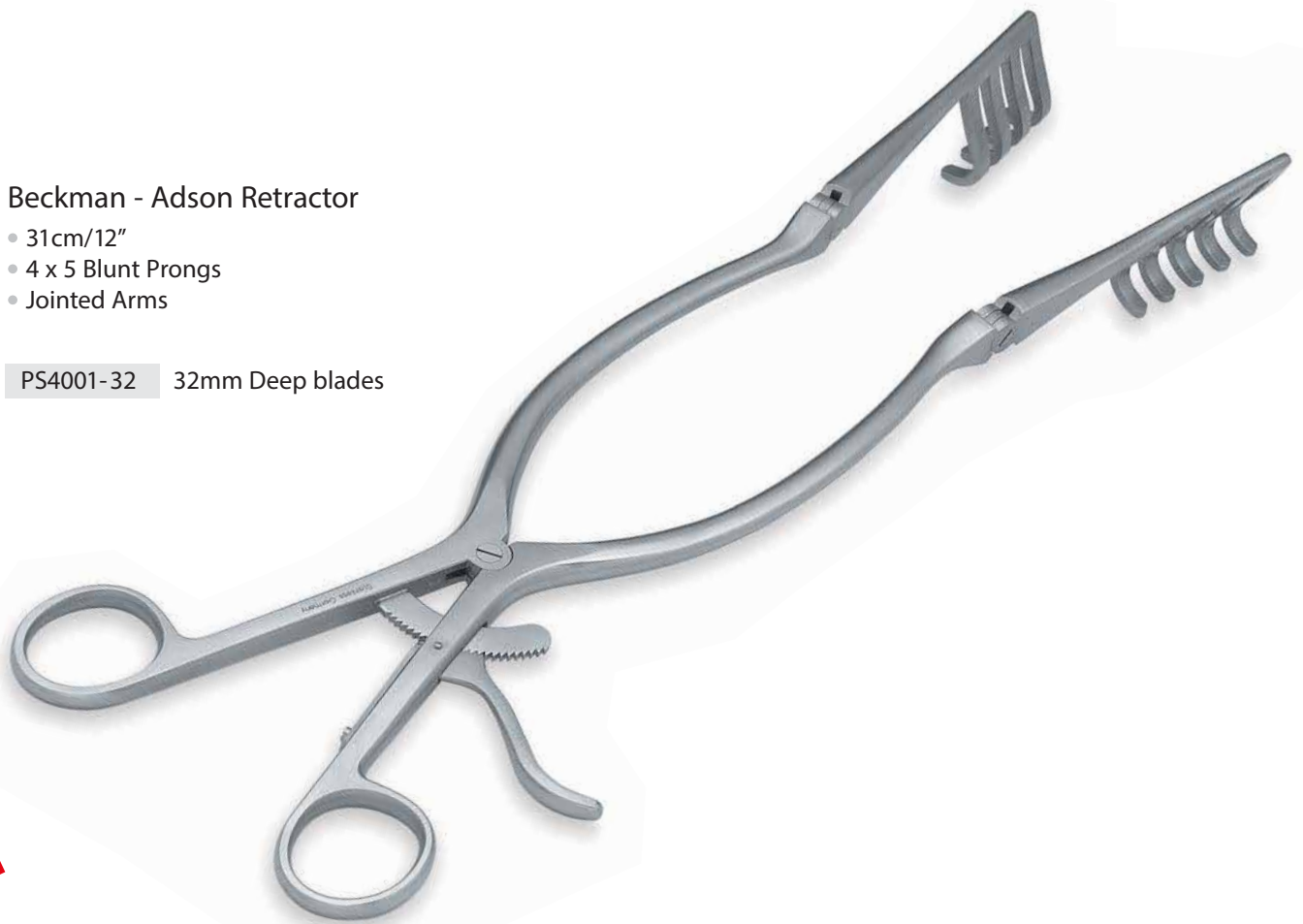

SELF RETAINING RETRACTORS

Gelpi Laminectomy Retractor

- Sharp Prongs

		Prong depth
18.5cm/7 1/4"	PS4030-16	30mm
19.5cm/7 3/4"	PS4050-16	50mm
20cm/8"	PS4070-16	70mm



Hardman Retractor

- 20cm/8"

	Prong depth
PS4550-20	50mm equal prongs
PS4500-20	long prong - Left*
PS4300-20	long prong - Right

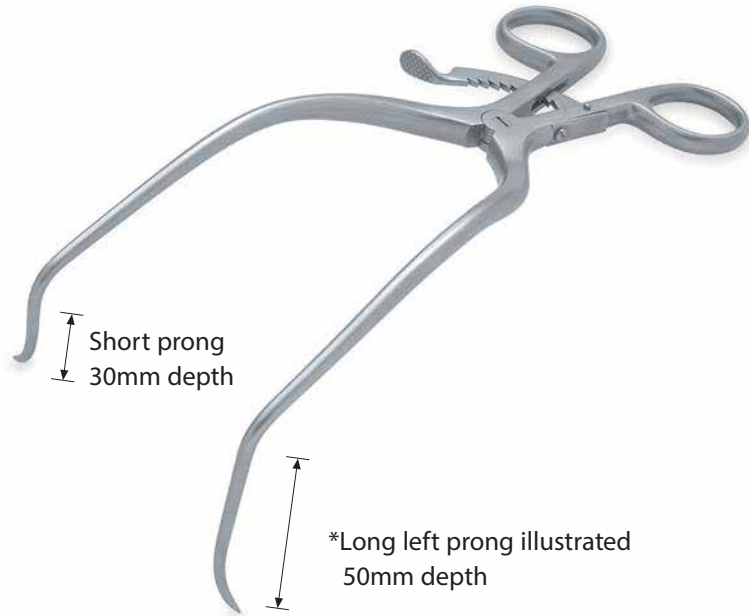

Meyerding Hemi Laminectomy Retractor

- 18cm/7"

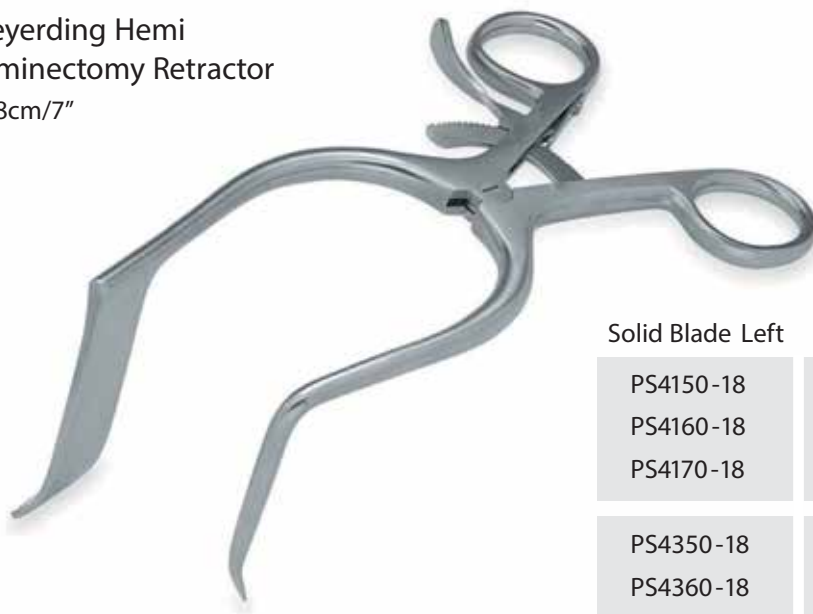

Solid Blade Left	Blade Size	Solid Blade Right	
PS4150-18	50 x 10mm	SP4250-18	Narrow Blade
PS4160-18	60 x 10mm	SP4260-18	
PS4170-18	70 x 10mm	SP4270-18	
PS4350-18	50 x 20mm	SP4450-18	Wide Blade
PS4360-18	60 x 20mm	SP4460-18	
PS4370-18	70 x 20mm	SP4470-18	

SELF RETAINING RETRACTORS

Long Gelpi Orthopaedic Retractor

- 30cm/11 ³/₄"
- Sharp Prongs

Depth Prongs

PS7245-10	70mm
PS7245-12	100mm

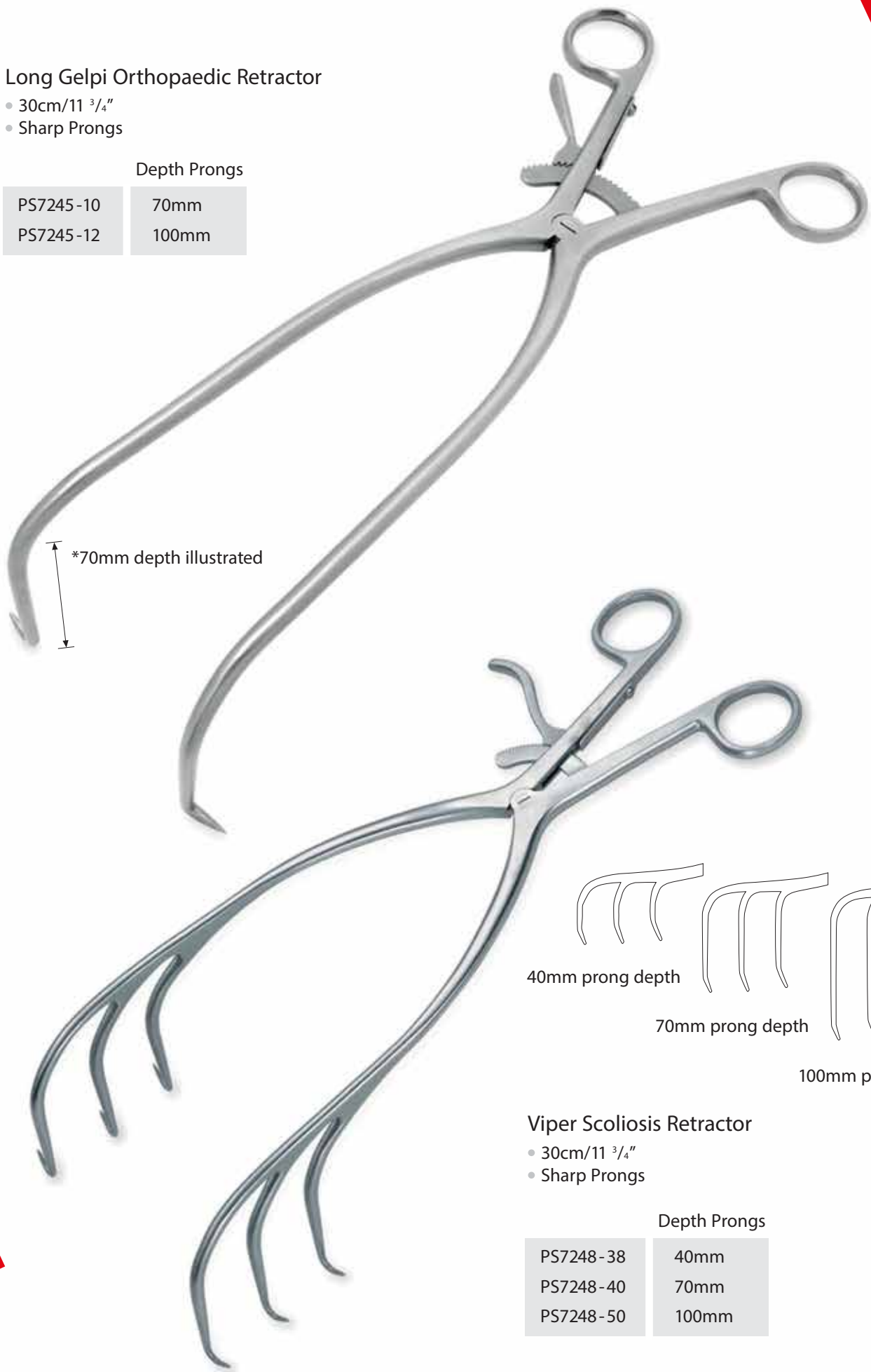

*70mm depth illustrated

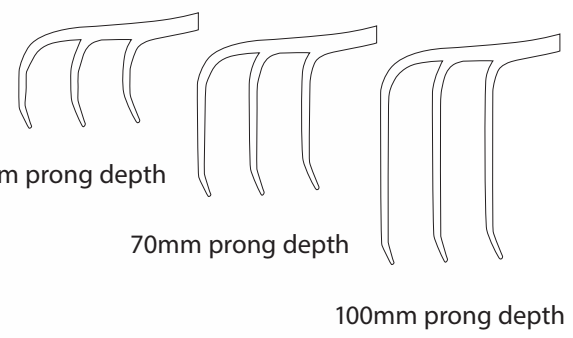

40mm prong depth

70mm prong depth

100mm prong depth

Viper Scoliosis Retractor

- 30cm/11 ³/₄"
- Sharp Prongs

Depth Prongs

PS7248-38	40mm
PS7248-40	70mm
PS7248-50	100mm



- This Specialist Retractor allows the Consultant the optimal exposure to the Disc with the minimum incision.
- The Design of the Retractor allows unhindered access around the wound with the jointed arms folding along the patients Back.
- The Black finish eliminates distracting reflections under the Microscope during Surgery.
- The wide selection of Blades available allows the Surgeon full flexibility in approaches to the Disc.

Basic Micro-Discectomy Retractor Set

PS5200-00

Complete set consisting of:

Qty	Order Code	Description
1 each	PS5202-00	Retractor Frame
4 pairs	PS5204-40	Wide Muscle Blades Sizes 4cm to 7cm depth
4 pairs	PS5206-40	Narrow Muscle Blades Sizes 4cm to 7cm depth
4 each	PS5208-40	Hook Blades Sizes 3cm to 6cm depth
4 each	PS5210-40	Toothed Blades Sizes 3cm to 6cm depth
1 each	PS5200-10	Instrument Container

Extended Micro-Discectomy Retractor Set

PS5200-01

Complete set consisting of:

Qty	Order Code	Description
2 each	PS5202-00	Retractor Frames
6 pairs	PS5204-60	Wide Muscle Blades Sizes 3cm to 8cm depth
6 pairs	PS5206-60	Narrow Muscle Blades Sizes 3cm to 8cm depth
6 each	PS5208-60	Hook Blades Sizes 2cm to 7cm depth
6 each	PS5210-60	Toothed Blades Sizes 2cm to 7cm depth
1 each	PS5200-10	Instrument Container

MICRO DISSECTOMY RETRACTOR



International Instruments

Jointed Arms



Retractor Frame

- Jointed arms
- Maximum spread 70mm

PS5202-00

Retractor Frame

- Rigid arms

PS5203-00

(Frame available with extra long rack 140mm spread)



Hook Blades

PS5208-02	2cm depth
PS5208-03	3cm depth
PS5208-04	4cm depth
PS5208-05	5cm depth
PS5208-06	6cm depth
PS5208-07	7cm depth
PS5208-08	8cm depth
PS5208-09	9cm depth
PS5208-10	10cm depth

Extra Deep



Wide Muscle Blades - 6 Teeth

Extra Deep

27mm width

PS5204-03	3cm depth
PS5204-04	4cm depth
PS5204-05	5cm depth
PS5204-06	6cm depth
PS5204-07	7cm depth
PS5204-08	8cm depth
PS5204-09	9cm depth
PS5204-10	10cm depth
PS5204-12	12cm depth



Narrow Muscle Blades - 4 Teeth

Extra Deep

20mm width

PS5206-03	3cm depth
PS5206-04	4cm depth
PS5206-05	5cm depth
PS5206-06	6cm depth
PS5206-07	7cm depth
PS5206-08	8cm depth
PS5206-09	9cm depth
PS5206-10	10cm depth
PS5206-12	12cm depth



Toothed Blades

PS5210-02	2cm depth
PS5210-03	3cm depth
PS5210-04	4cm depth
PS5210-05	5cm depth
PS5210-06	6cm depth
PS5210-07	7cm depth
PS5210-08	8cm depth
PS5210-09	9cm depth
PS5210-10	10cm depth

Extra Deep



Thin Muscle Blades - 2 Teeth

17mm width

PS5207-03	3cm depth
PS5207-04	4cm depth
PS5207-05	5cm depth
PS5207-06	6cm depth
PS5207-07	7cm depth
PS5207-08	8cm depth

MICRO DISCECTOMY INSTRUMENT SET

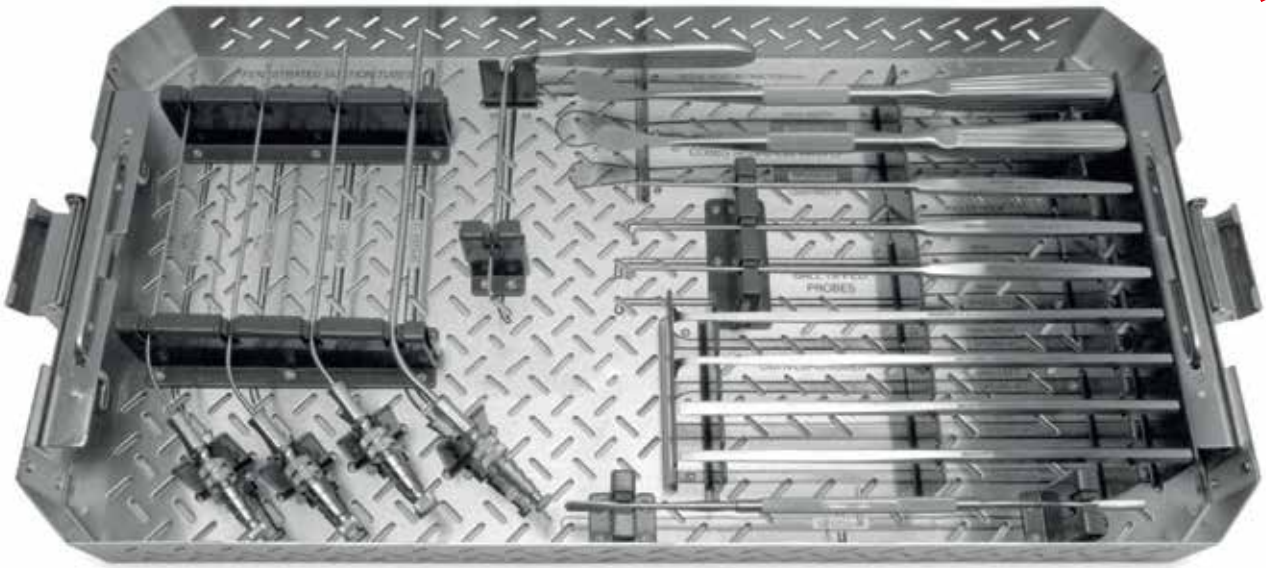

McCulloch Style Instrument Set with Container SP5200-05

Complete set consisting of:

Qty	Order Code	Description
1	PS5250-15	McCulloch Spinal Hook, 4mm tip - 23cm/9" length
1	PS5250-13	McCulloch Spinal Probe, 4mm tip - 23cm/9" length
1	PS5250-14	McCulloch Spinal Probe, 6mm tip - 23cm/9" length
1	PS5250-07	Cobbs Spinal Elevator, 12mm width - 26cm/10 1/4" length
1	PS5250-08	Cobbs Spinal Elevator, 19mm width - 26cm/10 1/4" length
1	PS5250-03	Spinal Osteotome, 4mm width - 22cm/8 1/2" length
1	PS5250-04	Spinal Osteotome, 6mm width - 22cm/8 1/2" length
1	PS5250-05	'Hockey Stick' Chisel, 5mm width - 22cm/8 1/2" length, curved right
1	PS5250-06	'Hockey Stick' Chisel, 5mm width - 22cm/8 1/2" length, curved left
1	PS5250-01	Elevator Double Ended, 24cm/9 3/4" length
1	PS5250-09	McCulloch Suction Tube, Fenestrated tip, 23cm/9" length, 6FG, 2.0mm Ø
1	PS5250-10	McCulloch Suction Tube, Fenestrated tip, 23cm/9" length, 7FG, 2.3mm Ø
1	PS5250-11	McCulloch Suction Tube, Fenestrated tip, 23cm/9" length, 9FG, 3.0mm Ø
1	PS5250-12	McCulloch Suction Tube, Fenestrated tip, 23cm/9" length, 12FG, 4.0mm Ø
1	PS5250-02	McCulloch Nerve Root Retractor, 90° angled, 6mm tip, 12.5cm/5" working length

McCulloch Style Spinal Hook/Probe

• 23cm/9" length

Hook
Tip 4mm



PS5250-15

Probe Ball
Tip 4mm



PS5250-13

Probe Ball
Tip 6mm



PS5250-14



MICRO DISCECTOMY SET

Cobbs Spinal Elevator

- 26cm/10 1/4" length

Width

PS5250-07	12mm
PS5250-08	19mm



Spinal Osteotome

- 22cm/8 1/2" length

Width

PS5250-03	4mm
PS5250-04	6mm



'Hockey Stick' Chisel

- 5mm Width
- 22cm/8 1/2" length

PS5250-05 Curved right

PS5250-06 Curved left



Elevator Double Ended

- 24cm/9 3/4" length

PS5250-01



McCulloch Suction Tube

- 23cm/9" length
- Fenestrated tip

FG

Diameter

PS5250-09	6FG	2.0mm Ø
PS5250-10	7FG	2.3mm Ø
PS5250-11	9FG	3.0mm Ø
PS5250-12	12FG	4.0mm Ø



McCulloch Nerve Root Retractor

- 90° Angled
- 6mm tip
- 12.5cm/5" working length

PS5250-02



'BLACK BELT' ADVANCED CERVICAL RETRACTOR SET

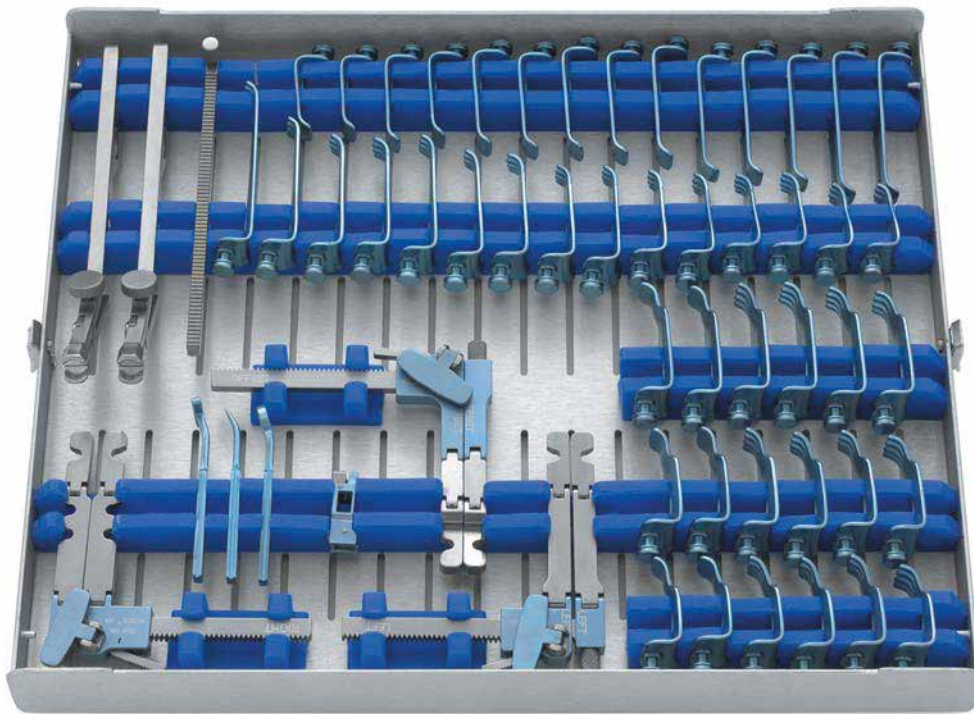

* Titanium Blade Set illustrated

An advanced Cervical retractor system suitable for both Anterior and Posterior Cervical Surgery but with attachments for Micro Discectomy Surgery.

Basic 'Black Belt' Cervical Retractor System

7320-00

Complete set consisting of:

Qty	Order Code	Description
1	7320-10	Retractor Frame RIGHT
1	7320-20	Retractor Frame LEFT
1	7320-30	Retractor Frame OFFSET
2	7320-40	Blade Insertion Clamps
14	7322-34/70	Pronged Blades 34mm-70mm
14	7324-34/70	Blunt Blades 34mm-70mm
12	7326-40/55	Two Level Pronged Blades 40mm-55mm
6	7328-40/55	Two Level Blunt Blades 40mm-55mm
1	7320-50	Container

Extended 'Black Belt' Cervical Retractor System

7320-05

Consisting of:

Standard 'Black Belt' Retractor with the addition of Micro Discectomy Attachments as detailed on page 56.

Coloured Titanium 'Black Belt' Cervical Retractor System

7320-00M

Complete set consisting of:

Qty	Order Code	Description
1	7320-10M	Retractor Frame RIGHT
1	7320-20M	Retractor Frame LEFT
1	7320-30M	Retractor Frame OFFSET
2	7320-40M	Blade Insertion Clamps
14	7322-34/70M	Pronged Blades 34mm-70mm
14	7324-34/70M	Blunt Blades 34mm-70mm
12	7326-40/55M	Two Level Pronged Blades 40mm-55mm
6	7328-40/55M	Two Level Blunt Blades 40mm-55mm
1	7320-50M	Container

Coloured Titanium Extended 'Black Belt' Cervical Retractor System

7320-05M

Consisting of:

Standard 'Black Belt' Retractor with the addition of Micro Discectomy Attachments as detailed on page 56.

'BLACK BELT' ADVANCED CERVICAL RETRACTOR SET

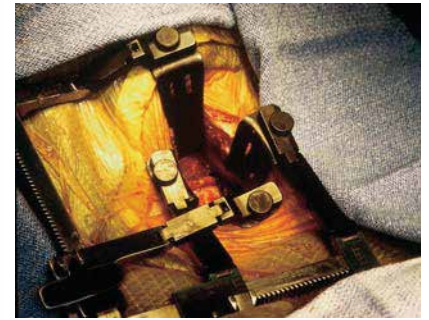

- Full jointed retractor arms
- Black non-glare finish
- Wide blade range
- Suitable for single or multi level retraction

Blades

- The blade shape is designed to resist climbing out of the surgical site
- The wider two level blades have an extra bend near the tip which follows the contour of the vertebrae for visualising



27mm wide two level Pronged blade 27mm wide two level blade 22mm wide Pronged blade 22mm wide Blunt blade 17mm wide optional narrow Cervical blades 40mm to 60mm depth

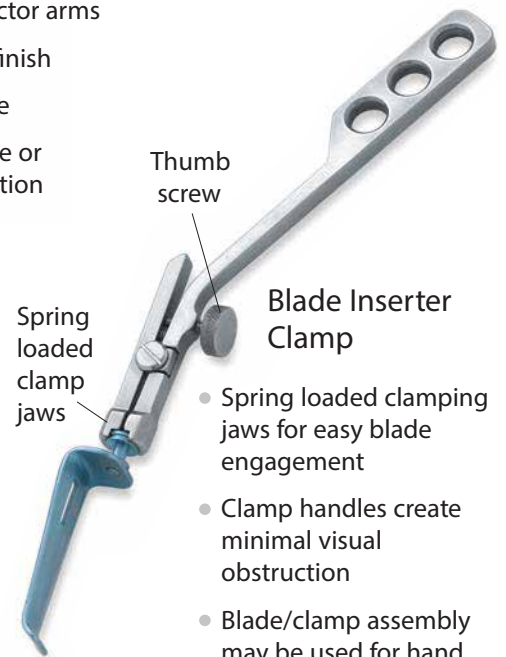

- Blade Inserter Clamp**
- Spring loaded clamping jaws for easy blade engagement
 - Clamp handles create minimal visual obstruction
 - Blade/clamp assembly may be used for hand retraction
 - Clamps are quickly/easily removed after retractor arms have securely engaged the blades

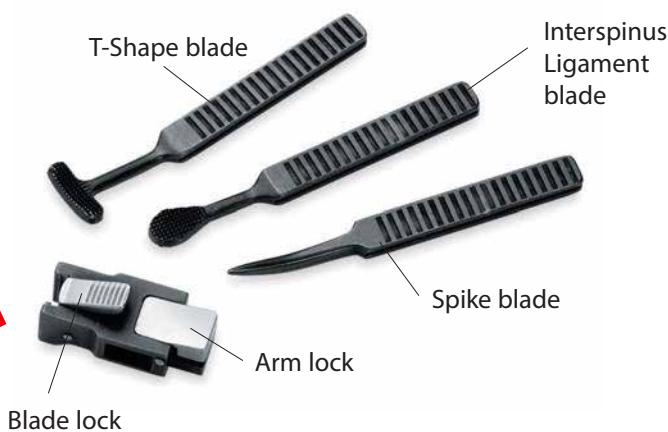

Lumbar Micro Discectomy Attachments

With this set the standard Cervical Retractor becomes a Lumbar Microdiscectomy Retractor unit.

7321-00

Complete set consisting of:

Qty	Order Code	Description
1	7321-10	Micro Disc attachment
1	7321-20	Spike Blade
1	7321-30	T-Shape Blade
1	7321-40	Inner Spine Ligament Blade
1	7321-85	Pronged Blade 85mm depth

SUPER-SLIDE II LAMINECTOMY RETRACTOR SET



* Titanium Blade Set illustrated

A powerful retractor with a selection of blade depths which can be positioned anywhere along the retractor arms. Allows excellent exposure of the spine in Pedicle Screw and Laminectomy procedures.

Super-Slide Retractor Basic Set

7329-00

Complete set consisting of:

Qty	Order Code	Description
1	7329-10	Retractor Frame
4	7329-20	Small blades 2" deep
4	7329-30	Medium blades 3" deep
4	7329-40	Large blades 4" deep
1	7329-50	Instrument container

Titanium Super-Slide Retractor Basic Set

7329-06

Complete set consisting of:

Qty	Order Code	Description
1	7329-10	Retractor Frame
4	7329-82	Small Titanium blades 2" deep
4	7329-84	Medium Titanium blades 3" deep
4	7329-86	Large Titanium blades 4" deep
1	7329-90	Instrument container

Super-Slide Retractor Extended Set

7329-05

Includes components of basic set plus:

Qty	Order Code	Description
4	7329-47	Supplementary blades 4 ³ / ₄ " deep
2	7329-60	Unilateral blade heads
2	7329-62	Unilateral T-blades

Titanium Super-Slide Retractor Extended Set

7329-09

Includes components of Titanium basic set plus:

Qty	Order Code	Description
4	7329-87	Supplementary Titanium blades 4 ³ / ₄ " deep
2	7329-60	Unilateral blade heads
2	7329-62T	Unilateral Titanium T-blades

SUPER-SLIDE II LAMINECTOMY RETRACTOR SET

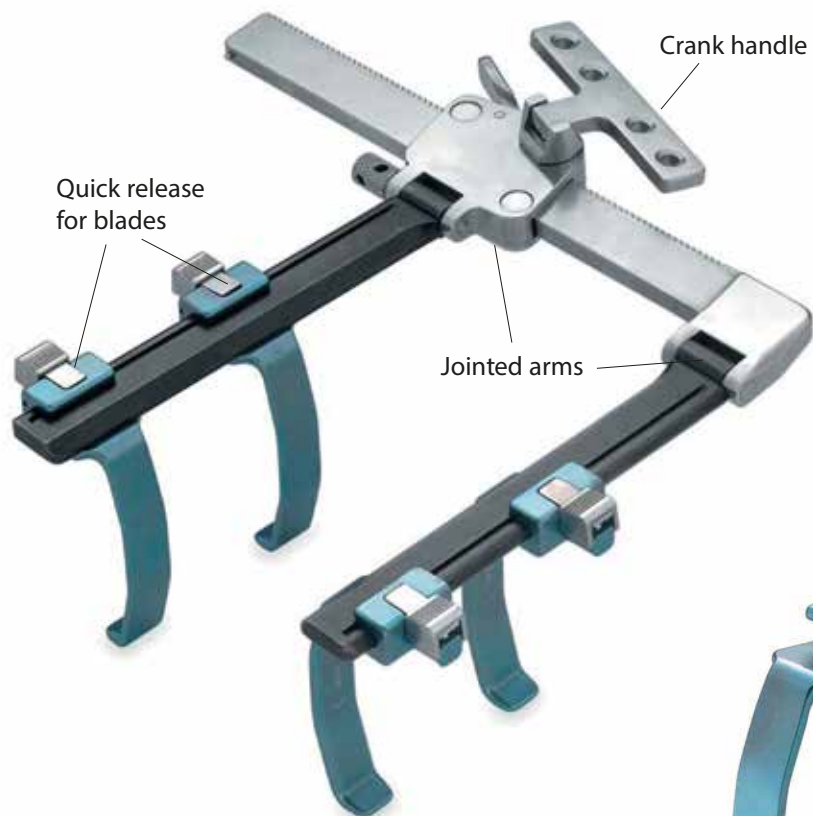

Super-Slide Retractor Blades

- Will not slip out of wound during surgery
- Narrow blade design minimizes potential of tissue necrosis at blade and tissue contact point
- Blades feature quick release locking system

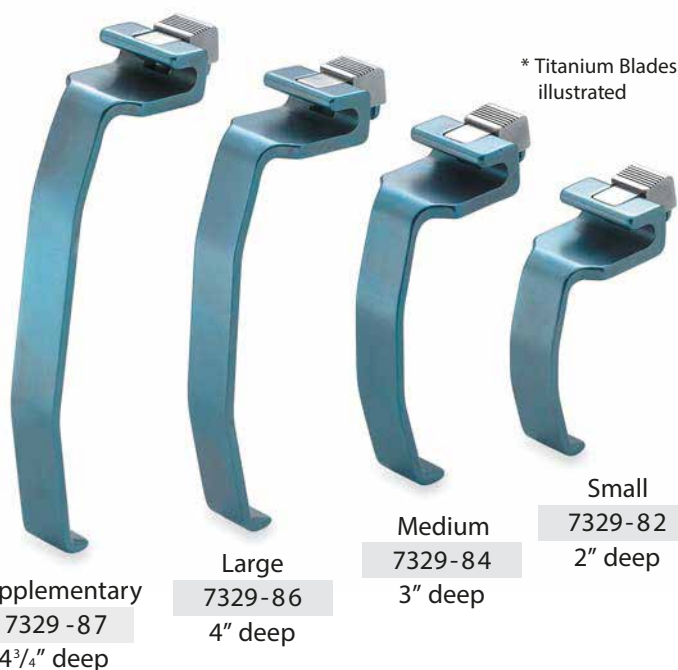
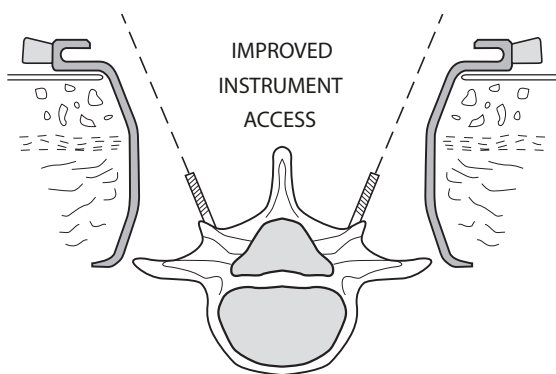

Unilateral Blade Attachment

- Blades lock into any chosen position along the retractor arms and may be changed at any time during surgery
- Arm locks allow the surgeon the choice of either attaching to the retractor arms then placing the unit into the wound or placing the blades into the wound then engaging the frame arms
- To obtain a unilateral exposure, use the unilateral blade attachments contained in the extended set. The T-Blade is designed to attain a firm purchase on the Spinous process
- The T-Blade can be adjusted to the correct depth with the blade lock

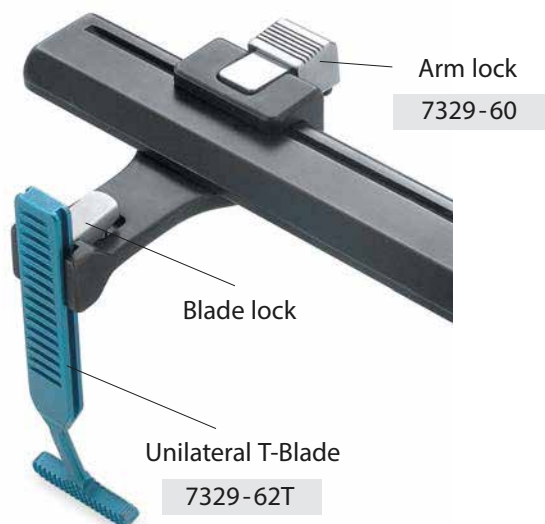

CASPAR MICRO LUMBAR DISCECTOMY RETRACTOR



Caspar Micro Discectomy Retractor

- This Retractor Set allows a micro surgery approach to Lumbar Disc
- Specula have a black surface finish to prevent glare
- Fenestrated blades on the specula reduce the risk of movement during surgery

Complete Set

SP5100-00

Consisting of:

Lateral Blades	Depth	Specula	Depth
PS5101-40	40mm	PS5100-40	40mm
PS5101-45	45mm	PS5100-45	45mm
PS5101-50	50mm	PS5100-50	50mm
PS5101-55	55mm	PS5100-55	55mm
PS5101-60	60mm	PS5100-60	60mm
PS5101-65	65mm	PS5100-65	65mm
PS5101-70	70mm	PS5100-70	70mm



SP5102-00

Counter Retractor Frame

SP5103-00

Blade Ejector Forceps

CASPAR MICRO LUMBAR DISCECTOMY RETRACTOR

Lateral Blades



Blade Ejector Forceps

PS5103-00



Specula Range



Caspar Micro Discectomy Retractor Frame

PS5102-00



BLACK BELT MICRO DISCECTOMY RETRACTOR SET



Black Belt Micro Discectomy Retractor Set

A specialist retractor for Lumbar Micro Discectomy Surgery featuring:

- Jointed retractor arms
- Adjustable blade depth
- Range of pronged blades
- Powerful ratchet action with quick release mechanism

7276-00 Complete Set

Complete set consisting of:

Qty	Order Code	Description
1	7276-10	Retractor Frame
1	7276-15	Blade Inserting Clamp
1	7276-20	Spike Blade
1	7276-30	T-Shape Blade
1	7276-35	Inner Spine - Ligament Blade
1	7276-40	Pronged Blade 40mm
1	7276-45	Pronged Blade 45mm
1	7276-50	Pronged Blade 50mm
1	7276-60	Pronged Blade 60mm
1	7276-70	Pronged Blade 70mm
1	7276-85	Pronged Blade 85mm
1	7276-90	Sterilising Container

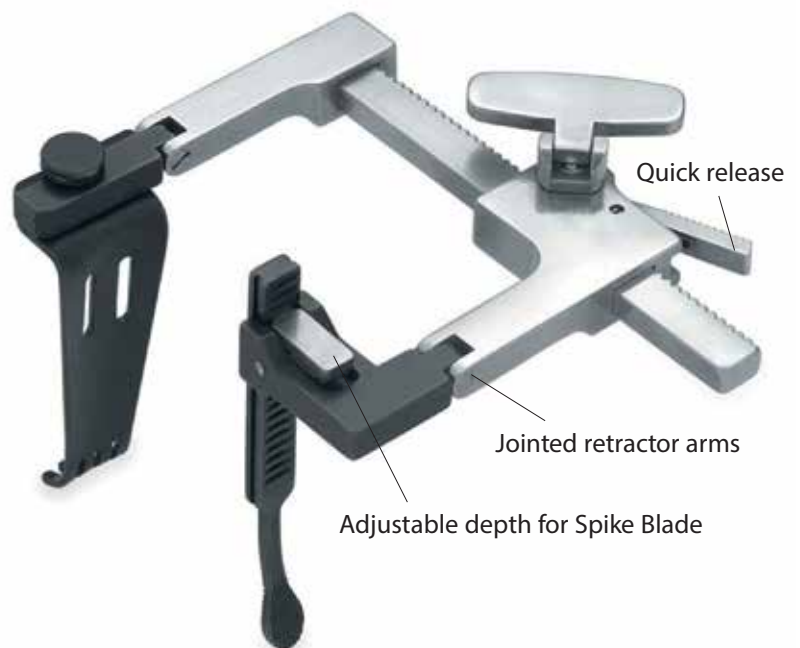

BAYONET MICRO INSTRUMENTS FOR DURAL REPAIRS

Yasargil Bayonet Micro Needle Holder

- Flat Handled
- Delicate 1mm Jaws



With Lock	Straight	Curved	Without Lock	Straight	Curved
23cm/9"	MV1012-23	MV1013-23	23cm/9"	MV1112-23	MV1113-23

Bayonet Micro Needle Holder

- Round Bodied
- Delicate 1mm Jaws



With Lock	Straight	Curved	Without Lock	Straight	Curved
21cm/8 1/4"	MV1010-21	MV1011-21	21cm/8 1/4"	MV1110-21	MV1111-21
23cm/9"	MV1010-23	MV1011-23	23cm/9"	MV1110-23	MV1111-23

Yasargil Bayonet Micro Forceps

- Flat Handled
- Blunt 1mm Tips



22.5cm/8 1/4"	MV2301-22
24cm/9 1/2"	MV2301-24

Yasargil Bayonet Micro Scissors

- Flat Handled
- 22.5cm/8 3/4" length



Standard Blade



Straight
PS3005-22



Curved
PS3006-22

Vannas Blade



Straight
PS3007-22



Curved
PS3008-22

BIPOLAR FORCEPS

Straight Bipolar Forceps

- 10.5cm/4 1/4" length



Tip Size

0.7mm	70 02 38
1mm	70 02 43
Blunt	70 02 41

Straight Bipolar Forceps

- 16.5cm/6 1/2" length



Tip Size

0.7mm	70 01 52
1mm	70 01 51

Straight Bipolar Forceps

- 19cm/7 1/2" length



Tip Size

0.7mm	70 01 72
1mm	70 01 71

Bayonet Bipolar Forceps

- 19cm/7 1/2" length



Tip Size

0.7mm	70 01 83
1mm	70 01 81
2mm	70 01 82

BIPOLAR FORCEPS

Bayonet Bipolar Forceps

- 23cm/9" length



Tip Size

0.3mm	70 01 90
0.7mm	70 01 91
1.2mm	70 01 92

Bayonet Bipolar Forceps

- 25cm/9 3/4" length



Tip Size

0.3mm	70 02 90
0.7mm	70 02 91
1.2mm	70 02 92

37-01-35L



- Fitting Block End Forceps
- Banana Plug Vallylab Machine Fitting
- 4.5 metre length

37-01-38L



- Fitting Block End Forceps
- Erbe BM780 Machine Fitting
- 4.5 metre length

Bayonet Bipolar Forceps Supergliss Non-Stick Tips

- 23cm/9"



0.4mm	78 01 99SG
0.7mm	78 01 91SG
1.0mm	78 01 98SG
1.2mm	78 01 92SG



The material specially developed for SuperGliss non-stick forceps prevents overheating of the tips during coagulation. Laboratory tests confirm the outstanding non-stick properties that last throughout the lifetime of the instrument.

Slim Nose Wire Twisters

- 19cm/7 1/2"

PS7645-19



Orthopaedic Locking Grips

- Hardened jaws



Length

200-511-180	18cm/7"	Small
200-511-200	20cm/8"	Medium
200-511-240	24cm/9 1/2"	Large

Combined Wire Cutter & Pliers

- 18cm/7"
- Suitable for wires up to 1.6mm

200-512-185



Bolt Cutters with dismantable arms

- Max. cap 6.3mm pins
- 57cm length

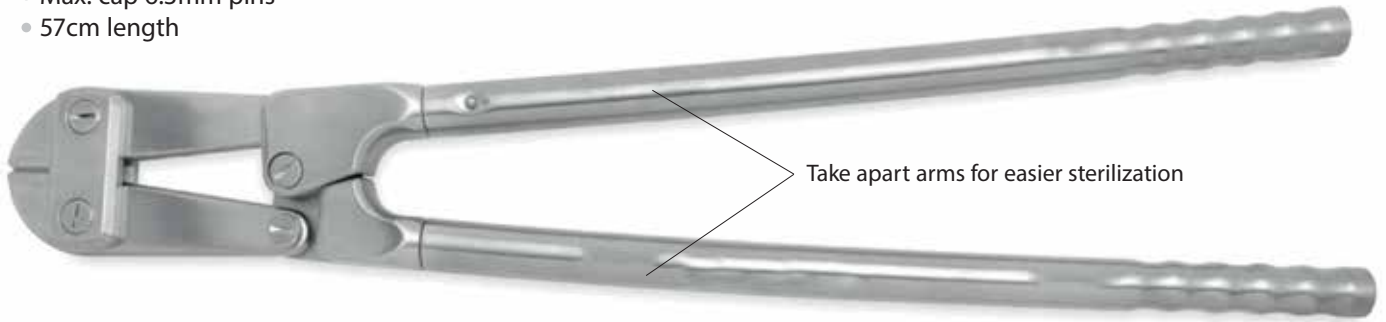

200-500-585

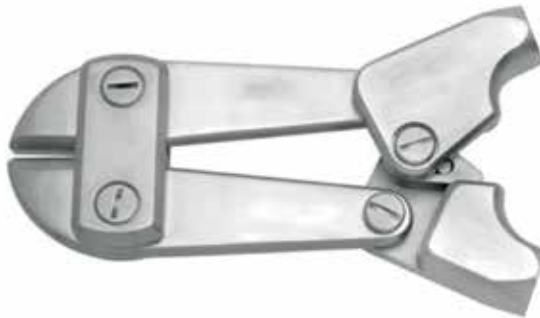

- Must be used in conjunction with a Rod Holder. Ordering Code: 200-675-200

Muller-Claus Wire Cutters

- Tungsten Carbide Jaws
- Double Action

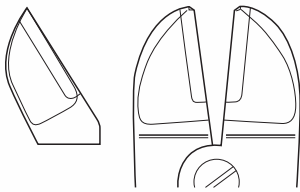

Length

8-810E18

18cm/7"

- Sui

8-800E22

22cm/8 3/4"

- Suitable for wires up to 3mm diameter

Needle Nosed Locking Pliers



Length

200-514-220

22cm/8 3/4"

Small

200-515-250

25cm/9 3/4"

Medium

200-516-300

30cm/11 3/4"

Large

- A very useful instrument for orthopaedic surgery allowing the surgeon to securely clamp on to wires and implants.

Measuring Caliper

- 25cm/10"

PS7334-20



Castroviejo Caliper

- 7cm/2 3/4"
- Measuring range 3mm to 25mm

PS7334-10



Vernier Caliper

- 22.5cm/9"
- Measuring range 15cm

PS7338-00



Depth Gauge

- Measuring depth up to 50mm

PS7350-00



Depth Gauge

- Measuring depth up to 70mm

PS7370-00



Direct Reading Depth Gauge

- 23cm length
- Measuring range 0.5 to 40mm

PS7333-10



Frazier Suction Tube

- 17cm/6 ³/₄"



PS9041-17	6FG	2.0mm
PS9042-17	7FG	2.3mm
PS9043-17	8FG	2.7mm
PS9044-17	9FG	3.0mm
PS9045-17	10FG	3.3mm
PS9046-17	11FG	3.7mm
PS9047-17	12FG	4.0mm

Frazier Suction Tube

- 23cm/9"



PS9041-23	6FG	2.0mm
PS9042-23	7FG	2.3mm
PS9043-23	8FG	2.7mm
PS9044-23	9FG	3.0mm
PS9045-23	10FG	3.3mm
PS9046-23	11FG	3.7mm
PS9047-23	12FG	4.0mm

Bayonet Dissecting Forceps



19cm/7 ¹/₂" Tip Size

PS9701-19	1mm
PS9702-19	2mm

21cm/8 ¹/₂" Tip Size

PS9701-21	1mm
PS9702-21	2mm



International Instruments

Designers & Manufacturers of Surgical Instruments

Corporate Office & Factory

337/N, Amala Antonian Plaza
Kinfra Park P.O., Thrissur (Dt.)
Kerala State, India - 680 309
Tel : +91 480 273 5959 / 5858

USA Office

12916 Edsel Dr.
Raleigh NC 27613
USA
Tel : +1 919 467 5278

Middle East Office

211 Bait Al Ali Building
Al-Khuwair, Muscat
Oman
Tel : +968 99053791

sales@myjjonline.com, myjjonline@yahoo.com

www.myjjonline.com